

SYQ 系列风机运行极限

SYQ Series Fan Operational Limits

			200	225	250	280	315	355	400	450	500	560	630	710	800	900	1000
极限吸收功率 Max. absorbed Power	L	KW	1.5	1.5	2	/	/	/	/	/	/	/	/	/	/	/	/
	R	KW	2	3	3	5.5	4.8	5.5	6.0	8.0	12	14	20	20	/	/	/
	K	KW	/	/	/	8	8	15	15	15	22	30	35	40	30	43	55
	Z	KW	/	/	/	/	/	/	/	/	30	38.5	40	60	65	65	80
	R2	KW	/	/	/	5.5	6.5	8.5	8.5	12	13	14	18	18	/	/	/
	K2	KW	/	/	/	/	/	13	13	18.5	22	32	34	45	45	45	65
极限转速 Max. R.P.M	L	rpm	4500	3700	3500	/	/	/	/	/	/	/	/	/	/	/	/
	R	rpm	4900	4500	4100	4000	3200	2800	2400	2200	2000	1800	1700	1400	/	/	/
	K	rpm	/	/	/	4500	4000	3800	3200	2800	2500	2400	2000	1700	1300	1200	1100
	Z	rpm	/	/	/	/	/	/	/	/	2800	2600	2200	2000	1600	1400	1300
	R2	rpm	/	/	/	3200	2800	2600	2100	1800	1600	1400	1200	1000	/	/	/
	K2	rpm	/	/	/	/	/	3000	2400	2200	2000	1800	1600	1400	1200	1000	900
极限温度 (最低-20℃) Air Temperature Limits (Min-20℃)	L	Max.	85	85	85	/	/	/	/	/	/	/	/	/	/	/	/
	R/R2	℃	85	85	85	85	85	85	85	85	85	85	85	85	/	/	/
	K/K2	Max.	/	/	/	85	85	85	85	85	85	85	85	85	85	85	85
	Z	℃	/	/	/	/	/	/	/	/	85	85	85	85	85	85	85
风机重量 Fan Weight	L	Kg	8	10	16	/	/	/	/	/	/	/	/	/	/	/	/
	R	Kg	10	12	18	22	32.6	42.7	50.6	67.5	84.2	142	168	223	/	/	/
	K	Kg	/	/	/	32	42.6	54.7	63.6	82.5	104.2	171	197	271	300	481.5	530
	Z	Kg	/	/	/	/	/	/	/	/	107	174	200	274	304	485	535
	R2	Kg	/	/	/	46	67	91	107	143	176	300	352	462	/	/	/
	K2	Kg	/	/	/	/	/	111	127	173	217	358	410	558	616	989	1086

本样本中所述的风机特性,如尺寸、性能参数等,本公司保留更改的权利,恕不另行通知;如有不明之处,请来电询问。
This fan features described in the sample, such as size, performance parameters, the Company reserves the right to change without notice; if unknown place, please call us.

SYH 系列离心式空调风机

Centrifugal Ventilators

浙江亿利达风机股份有限公司特此证明,此处所示 SYH 系列离心风机获得了加盖 AMCA 印章的授权。所示额定值系根据 AMCA 出版物 211 和 AMCA 出版物 311 所进行测试和程序确定,并符合 AMCA 认证额定值计划的要求。

这里描述的所有离心风机都已经取得了 AMCA 印章,其认证数据见第 135 页到 150 页。

Zhejiang Yilida Ventilator Co.,Ltd. certifies that the SYH Series fans shown herein are licensed to bear the AMCA Seal. The ratings shown are based on tests and procedures performed in accordance with AMCA Publication 211 and AMCA Publication 311 and comply with the requirements of the AMCA Certified Ratings Program.

All the Centrifugal Fans described herein are licensed to bear the AMCA Seal, and their certified ratings are shown on pages 135 through 150.

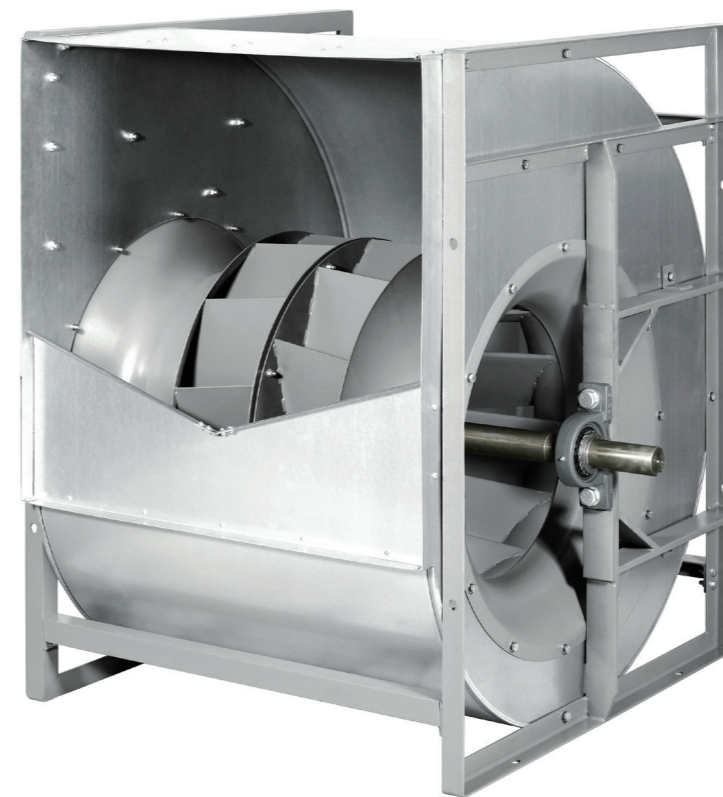

概述

SYH 系列后向离心式空调风机，叶轮采用后向机翼型叶片，具有通用性强、效率高、噪声低、耗能少、安全性好的特点。是各类中央空调机组及其它暖通空调、净化、通风等通风系统理想的配套产品。该样本中列出的 16 种规格风机，流量范围从 2000m³/h-300000m³/h，全压从 200Pa-3000Pa，均通过了 AMCA 国际认证，并取得 AMCA 印章。

Summary

The SYH Series of centrifugal fans with backward airfoil blade, They are licensed to bear the AMCA Seal for air performance, sound, and FEG. The SYH Series includes 16 models as described in this catalogue. The volume flow of the SYH Series ranges from 2,000 m³/h to 300,000 m³/h, the total pressure ranges from 200 Pa to 3,000 Pa. Some of the features and characteristics of these fans are: a wide range of applications, high efficiency, low noise, and low power consumption. These fans are ideal for use in central air-conditioning systems, in purifiers. They are also suitable for use in a variety of other ventilation applications.

命名方式

Nomenclature

SYH 500 K

结构型式 Construction type
R 型(基本型) Type R (Basic Model)
K 型(加强型) Type K (Heavy Duty Model)
Z 型(超重型) Type Z (Extra-heavy Heavy Model)

叶轮名义直径(mm) Nominal diameter of Wheel (mm)

后向机翼型离心风机系列代号 Fan series with backward airfoil blades

产品型式

Product Features

1. 旋向

SYH 系列风机可分为左旋(LG)和右旋(RD)两种旋转方式，从风机皮带轮一端正视，叶轮顺时针旋转的称为右旋风机，逆时针旋转的称为左旋风机。

1. Rotation

SYH series fans have two direction of rotations, left-hand rotation (LG) and right-hand rotation (RD); Viewing from drive side, if the Wheel rotates clockwise, it is left hand (LG) rotation. If the Wheel rotates counter clockwise, it is right-hand (RD).

2. 出风口方向

SYH 系列出风口可按图 1 所示制成 0°、90°、180°、270° 四种出风方向。

2. Discharge Direction

As shown in Fig1, SYH Series fans can be constructed in four discharge directions: 0°, 90°, 180°, and 270°.

图1 (Fig 1)

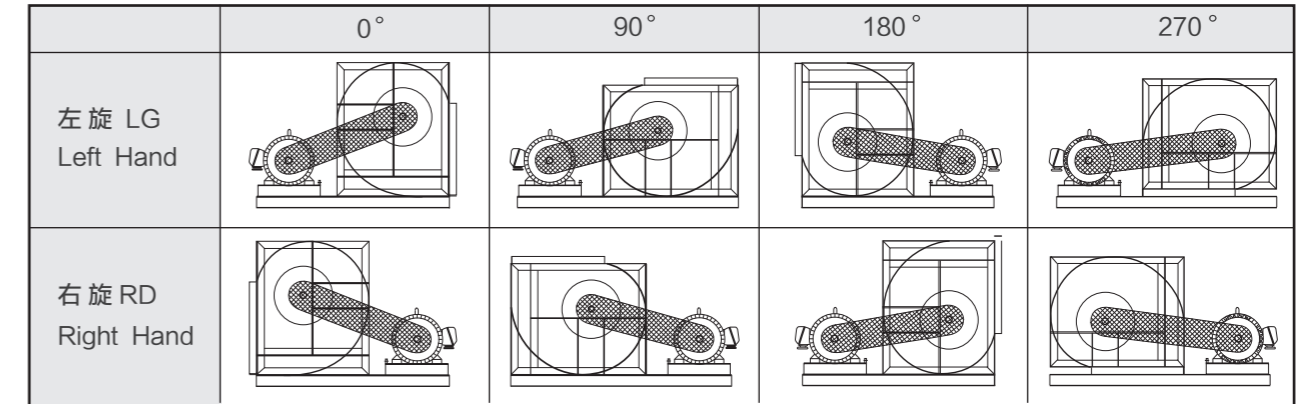

3. 结构形式

SYH 系列风机可按图 2 所示制成 R 型、K 型、Z 型、L2 型、R2 型。

3. Type of construction

As shown in Fig 2, SYH series fans can be divided into Category R . K, Z, Category L2 . R2.

图2 (Fig 2)

风机类型 Fan Type	机号 Fan Size	风机示意图 Fan Diagram	轴承实物图 Bearing Type
R 型 TYPE R	280-710		
K 型 TYPE K	280-1000		
Z 型 TYPE Z	280-1600		
R2 型 TYPE R2	200-500		
K2 型 TYPE K2	200-560		

产品结构

SYH 系列风机主要由机壳、叶轮、框架、轴承及轴构成。出口法兰（为可选件）。

1. 机壳

机壳采用热镀锌钢板制造，侧板具有符合空气动力学的外形，进风口整体拉伸成型，蜗板采用点焊或“Pittsburg seam locking”的连接方式与侧板连成一体。

2. 叶轮

后向叶轮采用优质冷轧钢板制成，按三元流理论设计的机翼型叶片焊接在高精度激光切割机床加工的中盘和端圈上，整体喷塑。所有叶轮进行静平衡和动平衡测试，内控精度达到 G2.5 级 (ANSI/AMCA 204-05)。

3. 框架

R 型风机框架采用热镀锌钢板剪切、折弯制成，TOX 连接保证了所需的尺寸精度和应有的刚度；K 型风机框架由角钢和扁钢冷弯焊接制成；Z 型风机框架由加宽加厚的角钢扁钢焊接制成。轴承安装位进行对称铣平面加工，表面喷塑处理，以保证足够的刚度和强度，同时保证安装轴和轴承的同心度。

4. 轴承

SYH 系列风机均采用优质滚珠轴承，并根据噪声最低来选择，该轴承设有加润滑油的孔，已预先加润滑油并自动对中；L、R 型风机的轴承安装在轴承支架上，并设有防振垫圈；K 型风机则采用带座向心球轴承；Z 型风机采用重载荷的双列滚柱轴承的轴承箱结构。轴承寿命为 $L_{10} \geq 100000$ 小时。

5. 轴

风机轴采用 40Cr 低合金钢，经车、调质热处理、磨削制成，强度高，挠度小，严格控制轴径尺寸公差及形位公差，每根轴均经过涂覆防锈处理。轴尺寸设计应满足第一临界转速至少为风机最大运行转速的 1.4 倍。

6. 出风口法兰

法兰采用热镀锌钢板制成，法兰与蜗壳的连接采用 TOX 免焊工艺，外观精美，并具有足够的刚度与强度。

Construction of Product

SYH series fans are mainly constructed of housing, Wheel, frame, bearing and shaft. Outlet flange (is optional).

1. Housing

The housing is made of hot galvanized steel sheet. The side plates include inlets cones that are designed with the best aerodynamics for inlet condition. The scroll is fixed to the side plates by spot welding or "Pittsburg seam locking."

2. Wheel

Backwards curved airfoil Wheel is constructed of high-grade cold-roll steel sheets, according to the three-dimensional flow theory, the Wheel is fixed on the center plate and on the end ring with welding by high precision laser cutting machine. the unity of the Wheel is spraying by plastic. All Wheels are balanced to ANSI/AMCA Standard 204-05. Yilida's internal standard is G2.5 or higher for wheel balancing.

3. Frame

The frames for type R construction are made of galvanized steel angle iron bars. The cutting and bending of the frame parts, as well as the TOX connections, are formed with the use of toolings to ensure the high accuracy and the rigidity of the frames; The frames for K constructions are welded by angle steel and flat steel, the frames for Z constructions are welded by thicker angle steel and flat steel, and finished with polyester coating in order to ensure sufficient rigidity and strength. The bearing supports are machined to ensure proper installation and alignments of the bearings.

4. Bearings

Ball bearings are used in all of the SYH Series fans. These are high-quality bearings and selected to minimize the fan noise levels. The bearings are pre-lubricated, sealed, and self-centering. For type R and L constructions, the bearings are supplied with lubrication fittings. For type K constructions, the bearings are supplied with lubrication fittings. For type Z, the bearings are supplied with heavy lift double-row ball bearing. Yilida bearing service life (L_{10}) are over 100,000 hours ($L_{10} \geq 100000$ hours).

5. Shaft

The shafts are made of 40 Cr carbon steel bars. The shafts are rough machined and then stress relieved with heat treatment before final machining. The shaft diameters are machined to very accurate tolerance levels, and they are fully checked to ensure precision fit. Each shaft is made turned, ground and polished. They are coated after assembly to provide corrosion resistance. Shaft size should be designed to meet the first critical speed of at least fan maximum running speed 1.4 times.

6. Outlet Flange

The outlet flange is made of galvanized steel. The connections of the flange components to the scroll are made using a TOX non-welding process. This maintains a good flange appearance while also providing sufficient strength and rigidity.

风机性能

1、风机选型示意图例

型号 Type	710K
风量 Volume	$q_v = 35000 \text{ m}^3/\text{h}$
全压 Total Pressure	$P_{tF} = 1200 \text{ Pa}$
动压 Dynamic Pressure	$P_{dF} = 87 \text{ Pa}$
出口速度 Outlet Velocity	$C = 12.06 \text{ m/s}$
风机转速 Fan Speed	$n = 1312 \text{ r/min}$
轴功率 Shaft Power	$P_{sh} = 16.24 \text{ KW}$
A声功率级 A Sound Power Level	$L_{wA} = 94 \text{ dB(A)}$
全压效率 Total Efficiency	$\eta_{tF} = 78.1 \%$

Performance Chart

1. Fan Performance Curve

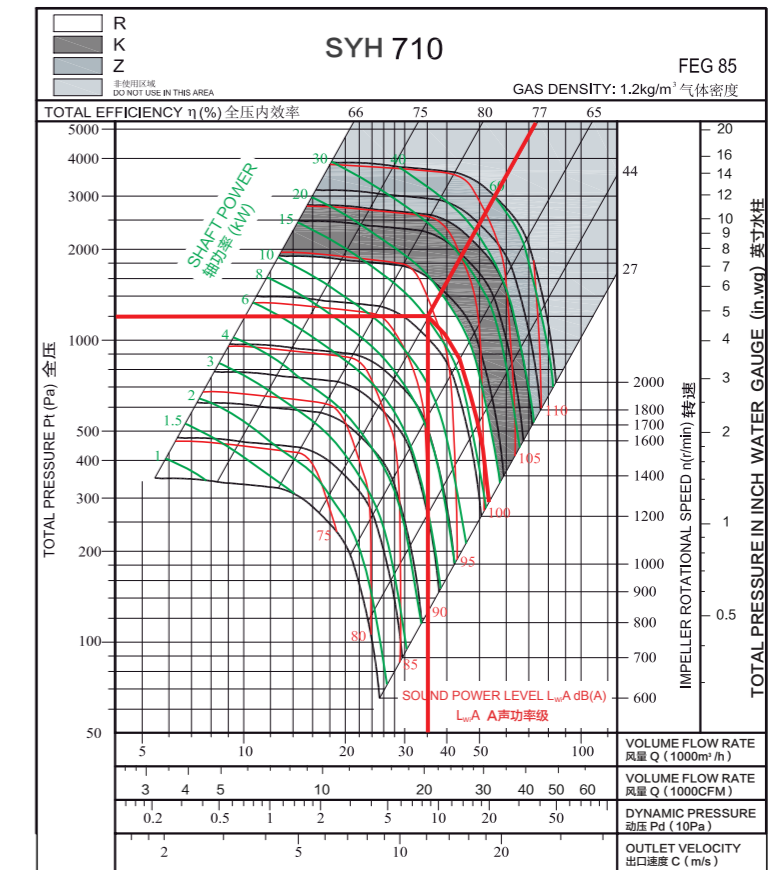

2、电机的选配

性能曲线图上的功率 P_{sh} 是指风机的轴功率。

配套电机的功率: $P_{sh,p} = P_{sh} \times K \div \eta_{me}$

风机传动效率的取值方法可参照表 1,

电机容量安全系数的取值方法可参照表 2。

表1 (Table 1)

风机传动方式	Drive Type	η_{me}
电机直联传动	Motor Direct Drive	1
联轴器直联传动	Coupling Direct Drive	0.98
三角皮带传动	V-Belt Drive	0.95

3. 双联风机的性能计算

L2 型、R2 型、K2 型双联风机性能与 L 型、R 型、K 型风机曲线上所示性能比较, 在压力相同的情况下, 双联风机性能如下:

风量 x 2	转速 x 1.05
轴功率 x 2.15	噪声 + 3 dB

双联风机的性能未获得 AMCA International 授权。

2. Motor selection

The power (P_{sh}) on the performance chart refers to the shaft power of the fan.

The rated power of the drive motor equals the total required shaft input multiplied by the safety factor: $P_{sh,p} = P_{sh} \times K \div \eta_{me}$. The value of mechanical drive efficiency can be obtained from Table 1.

The required safety factors is provided in Table 2.

表2 (Table 2)

电机功率	Power of electric motor (kW)	K值 Value k
≤ 2.2 kW		1.2
≤ 7.5 kW		1.15
≥ 11 kW		1.1

3. The twin fan performance calculation

Comparing the performance of the twin fan of Category L2, R2 and K2 with the comparable single fan performance of L, R and K. In the same condition of pressure, the twin fans' performance are as the following:

Volume x 2	RPM x 1.05
Shaft Power x 2.15	Noise + 3 dB

Performance of twin ventilators are not licensed by AMCA International.

8. 关掉风机, 移动电机座以调整张紧度, 当风机工作时, 皮带紧的一边是两个皮带轮连成的一条直线, 松的一边有轻微弧形。

图 3 (Fig2)

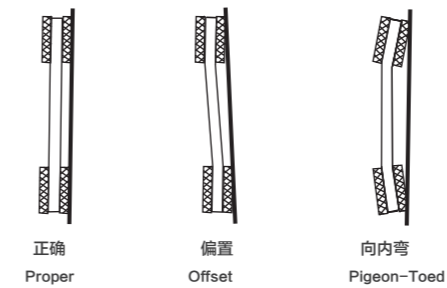

B) 皮带松紧度

合适的皮带松紧度对使用寿命来说很重要, 太紧会给皮带和轴承带来额外的负载, 降低它们的使用寿命, 太松会出现皮带打滑现象而产生热能并降低使用寿命。

皮带松紧度量具用来判断皮带是否松紧合适。量具本身带有一个尺表, 根据皮带轮中心距和皮带横截面确定皮带张紧力的大小, 如图 4 和表 3。

如没有皮带张紧度量具, 应调节皮带松紧至风机启动时皮带不发生尖叫为止, 如发生短促的叫声是允许的。

拉紧皮带后、开动风机之前, 重新检查皮带轮的对齐情况, 如右必要则重新调整对齐。新皮带在开始使用时可能有点拉伸, 则应在运行几天后重新检查皮带张紧度。

8. Switch off the fan, adjust the belt tension by moving the motor base. When in operation, the tight side of the belts should be in a straight line from sheave to sheave and there should be a slight bow on the slack side.



B) Belt tension

A proper level of belt tension is required in order to obtain a satisfactory belt life. If the belt tension level is too high, excessive loads will be imposed on the belts and the bearing, and this will reduce the lives of both of these components. If the belt tension level is too low, the belt will slip. Belt slippage generates a large amount of heat, and this heat will drastically reduce the life of a belt.

Belt-tensioning gauges can be used to determine whether the belts are tensioned properly. A chart is normally supplied with the gauge which indicates the ranges of forces required to deflect the belts by a given amount to obtain the proper belt tension level. The required forces are based upon the center distance of the sheaves and the belt cross-section. The belts are properly tensioned when the forces required to deflect the belt are within the specified range, see Fig 4 and Table 3.

If a belt-tensioning gauge is not available, then the belt should be tightened just enough so that the belt does not squeal when the ventilator is started. A very short period of noise during the starting of a ventilator is allowable, but a squeal lasting several seconds or longer is not acceptable. After tensioning the belts and before starting the fan, check to make sure that the sheaves are properly aligned. Realign the sheaves if necessary. Note that new belts may stretch a little during initial use, so the belt tension level should be checked after a few days of operation.

安装与维护

A) 皮带传动安装

1. 拆除风机轴端的保护并检查有无缺口和毛刺;
2. 检查风机和电机轴之间的平行度;
3. 中心距控制在 $0.7(d1+d2) < a < 2(d1+d2)$, 前向风机皮带速度应控制在 10~15m/s; 后向风机皮带速度应控制在 25~35m/s;
4. 将皮带轮套在轴上滑进去, 不要敲击, 以免损伤轴承;
5. 用一根直尺把风机和电机上的带轮对齐并紧固;
6. 把皮带套进皮带轮, 不要撬、挤压, 以免损伤皮带;
7. 调整张紧度直至皮带看起来松紧适度, 风机运行几分钟后, 再调整皮带至合适的张紧度;

Installation and Maintenance

A) V-belt drive Installation

1. Remove the protective coating from the ends of the fan shaft and ensure that the shaft ends are free of nick and burrs.
2. Check fan and motor shafts for alignment.
3. The center distance must be controlled as $0.7(d1+d2) < a < 2(d1+d2)$. The belt speed of forward curve fan should be more than 10m/s, but less than 15m/s, ($10 < v < 15$ m/s). The belt speed of backward curve fan should be more than 25m/s, but less than 35m/s ($25 < v < 35$ m/s).
4. Slide sheaves on to the shafts, Do not hammer the sheaves on to the shafts with force as this may result in bearing damage.
5. Align fan and motor sheaves with a straight-edge, and tighten the sheaves.
6. Place belts over the sheaves with care. Do not bend or squeeze the belts or it might get damaged.
7. Adjust the belt tension until the belts appear snug. Run the unit for a few minutes and allow the belts to set properly.

与中心距有关的皮带张紧度指示
Belt tension indicator applied to mid centre distance.

表4 (Fig4)



表3 (Table3)

皮带截面 Belt Section	使皮带向下移动16mm径向距离1米所需的力 Force required to deflect belt 16mm per metre of span		
	张紧力 (小皮带轮直径) Small Pulley Diameter (mm)	牛顿 Newtonian (N)	千克力 Kilogram force (Kgf)
SPZ	56-95	13-20	1.3-2.0
	100-140	20-25	2.0-2.5
SPA	80-132	25-35	2.5-3.6
	140-200	35-45	3.6-4.6
SPB	112-224	45-65	4.6-6.6
	236-315	65-85	6.6-8.7
SPC	224-335	85-115	8.7-11.7
	375-560	115-150	11.7-15.3
A	80-140	10-15	1.1-1.5
B	125-200	20-30	2.0-3.1

C) 轴承润滑

风机使用带座轴承，可通过加油嘴注入润滑油。润滑油有效期取决于油脂类型、轴承的转速和工作温度。判断是否加油的最好办法是当加新油时观察清除下来的旧油脂，可延长换油脂的间隔，如果清除下来的油脂比新的黑得多表明油脂已氧化，应缩短换油脂的间隔。

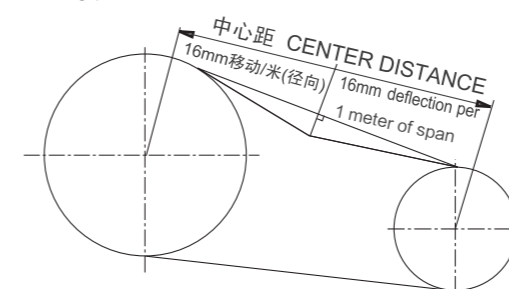
C) Bearing Lubrication

The fan bearings are filled with lubricant when they ship from the factory, so the bearings do not require any additional grease to be supplied before starting the fan. The fans that are equipped with pillow block bearing are provided with lubrication fittings, and these fittings allow for additional lubrication to be supplied to the bearings at regular intervals. The allowable period of time between lubrication of these bearings depends upon the operating speeds and temperatures of the bearing as well as on the type of lubrication. It is recommended to inspect the condition of the grease that is discharged from the bearings when new grease is added. If the discharged grease looks similar to the new grease, then a longer period of time between lubrications is possible. If the discharged grease is much darker than the new grease, this indicates that the grease is being oxidized and more frequent lubrications of the bearings are required.

说明

- 1). 订货时须注明风机型号、转速、风量、风压、出风口方向和旋转方向。若需配套皮带、皮带轮、电机、安装底座等配件及其它特殊要求可在订货时提出。
- 2). 在安装前应对风机各部件进行检查，对叶轮、主轴和轴承等主要机件应重点细致检查，如有损伤应修复后再安装使用。
- 3). 检查机壳和其它壳体内部，不应有掉入、遗留的工具和杂物。
- 4). 风机正式运转前，需检查电机的转向是否符合风机转向的要求。
- 5). 风管与出风口之间应采用软连接，接头不得拉紧。
- 6). 风机安装后用手或杠杆拨动叶轮，检查是否过紧或碰撞现象，确认无这些现象时方可进行试转。
- 7). 风机配用电动机功率是指在特定工况下，风机内功率加上机械损失与电机容量安全系数而言，并非出风口全敞开时所需的功率。为防止电机超功率运行而烧毁，严禁风机出风口或进风口不接管路或未加外界任何阻力进行空运转。
- 8). 风机在无较大腐蚀性气体、不含酸（碱）性和尘粒物质 $150\text{mg}/\text{m}^3$ 的气体、-20°C <math><85^\circ\text{C}</math> 的气体环境下使用，风机在运输装卸过程中应小心轻放，防止碰撞挤压。

Instructions

- 1) When placing the order, it is necessary to state the type of fan, speed, air volume, air pressure, discharge direction, rotation direction, type of electric motor and its specifications.
- 2) Prior to installation, the fan should be carefully inspected. Special care should be taken in checking the shaft, Wheel and bearings. If there is an indication of any damage, the damaged parts should be repaired or replaced before the fan is installed or commissioned.
- 3) The inside of the scroll and casing need to be checked to make sure that there are no foreign objects inside the housing, such as tools or loose parts.
- 4) The rotational directions of the motor and Wheel should be checked to ensure that they are in compliance with the specification and purchase orders.
- 5) A flexible connector should be used between the fan out let flange and its mating ductwork. The flex connector should not be over-stretched.
- 6) Following the installation, the Wheel should be turned by hand or with the use of a wrench to make sure that it turns freely without colliding with other parts of the fan. Once all this is done, the fan can be commissioned normally.
- 7) The rated motor power as calculated herein might not be sufficient to drive the fan with an unrestricted discharge flow. Operating the fan with an unrestricted discharge outlet will result in flow rate that exceeds the specified fan capabilities. Such operation will quickly burn the motor and damage the fan. Great care must be taken in operating the fan to make sure that the maximum rated flows, as provided on the performance charts in this catalog, are not exceeded.
- 8) The fan is limited for use in areas where air substances are non-corrosive, non-toxic and non-erosive and where dust particles are less than $150\text{mg}/\text{m}^3$ with a temperature between -20°C and 85°C. Special care should be taken during transportation, load and unload.

技术参数

Technical Data

Wheel diameter 叶轮直径	D = 280 mm	Fan weight 风机质量	m = 32 kg
Moment of inertia 转动惯量	J = 0.082 kgm ²	Speed limit 极限转速	n _{max} = 4500 r/min

性能曲线

Performance Curve

经认证的性能是B类安装：自由入口，管道出口。功率额定值(kW)不包括传输损失。各项性能额定值不包括附属物(附件)的影响。所示A加权声音性能额定值已按AMCA International标准301计算。所示值为安装类型B：自由入口，管道出口的声功率级（入口L_{wA}）。

Performance certified is for installation type B: free inlet, ducted outlet. Power rating (kW) does not include transmission losses. Performance ratings do not include the effects of appurtenances (accessories). The A-weighted sound ratings shown have been calculated per AMCA International Standard 301. Values shown are for inlet L_{wA} sound power levels for installation type B: free inlet, ducted outlet.

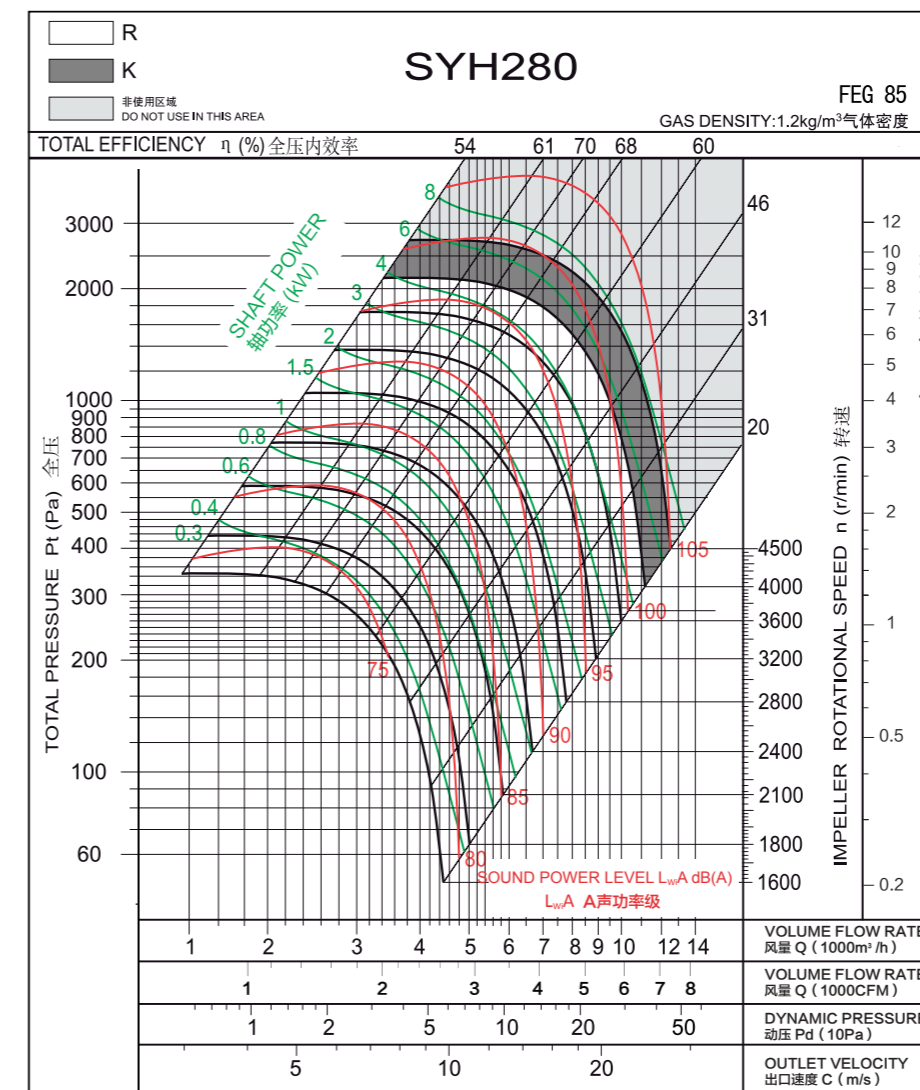

Measured in installation B according to AMCA Standard 210:

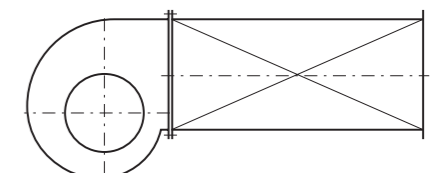

技术参数

Technical Data

Wheel diameter 叶轮直径	D = 315 mm	Fan weight 风机质量	m = 42.6 kg
Moment of inertia 转动惯量	J = 0.126 kg·m ²	Speed limit 极限转速	n _{max} = 4000r/min

技术参数

Technical Data

Wheel diameter 叶轮直径	D = 355 mm	Fan weight 风机质量	m = 54.7 kg
Moment of inertia 转动惯量	J = 0.27 kg·m ²	Speed limit 极限转速	n _{max} = 3800 r/min

性能曲线

Performance Curve

经认证的性能是B类安装：自由入口，管道出口。功率额定值(kW)不包括传输损失。各项性能额定值不包括附属物(附件)的影响。所示A加权声音性能额定值已按AMCA International标准301计算。所示值为安装类型B：自由入口，管道出口的声功率级（入口L_{WA}）。

Performance certified is for installation type B: free inlet, ducted outlet. Power rating (kW) does not include transmission losses. Performance ratings do not include the effects of appurtenances (accessories). The A-weighted sound ratings shown have been calculated per AMCA International Standard 301. Values shown are for inlet L_{WA} sound power levels for installation type B: free inlet, ducted outlet.

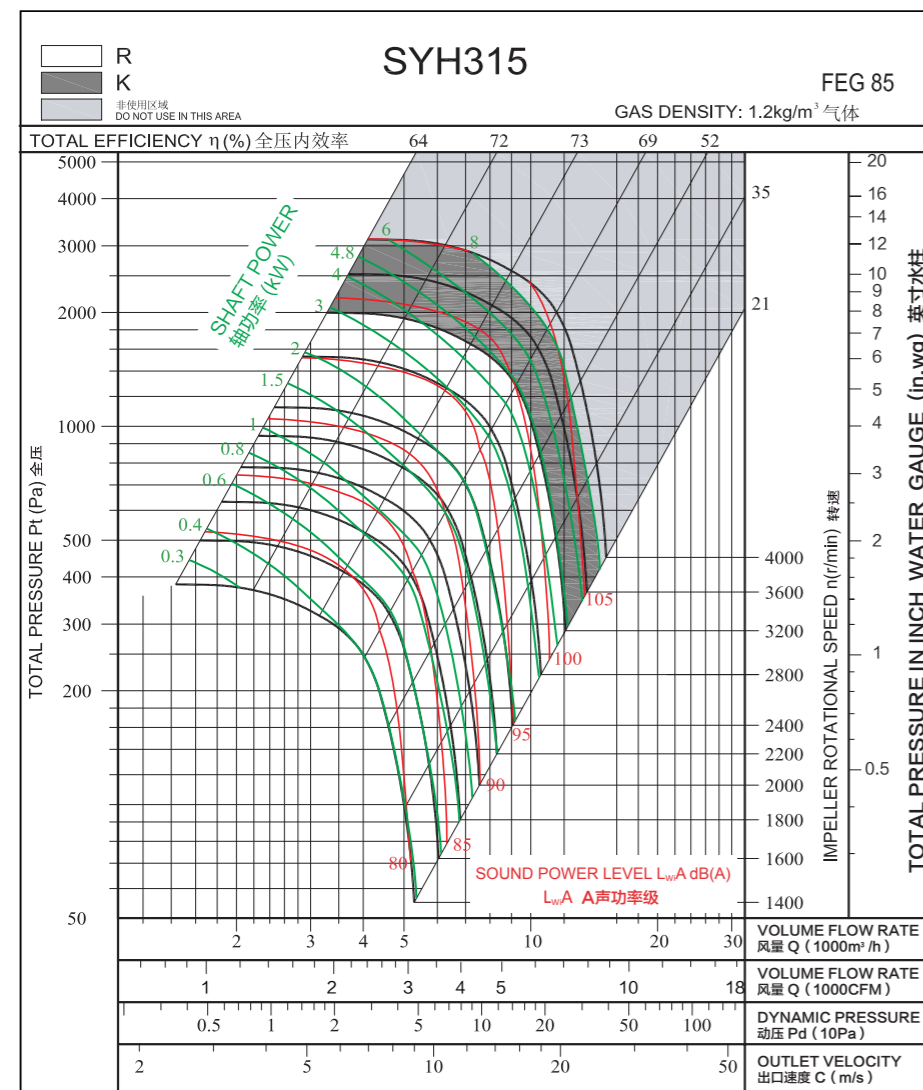

Measured in installation B according to AMCA Standard 210:

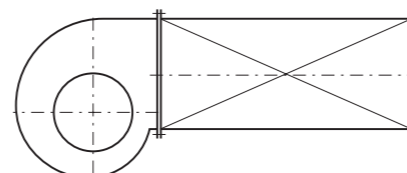

性能曲线

Performance Curve

经认证的性能是B类安装：自由入口，管道出口。功率额定值(kW)不包括传输损失。各项性能额定值不包括附属物(附件)的影响。所示A加权声音性能额定值已按AMCA International标准301计算。所示值为安装类型B：自由入口，管道出口的声功率级（入口L_{WA}）。

Performance certified is for installation type B: free inlet, ducted outlet. Power rating (kW) does not include transmission losses. Performance ratings do not include the effects of appurtenances (accessories). The A-weighted sound ratings shown have been calculated per AMCA International Standard 301. Values shown are for inlet L_{WA} sound power levels for installation type B: free inlet, ducted outlet.

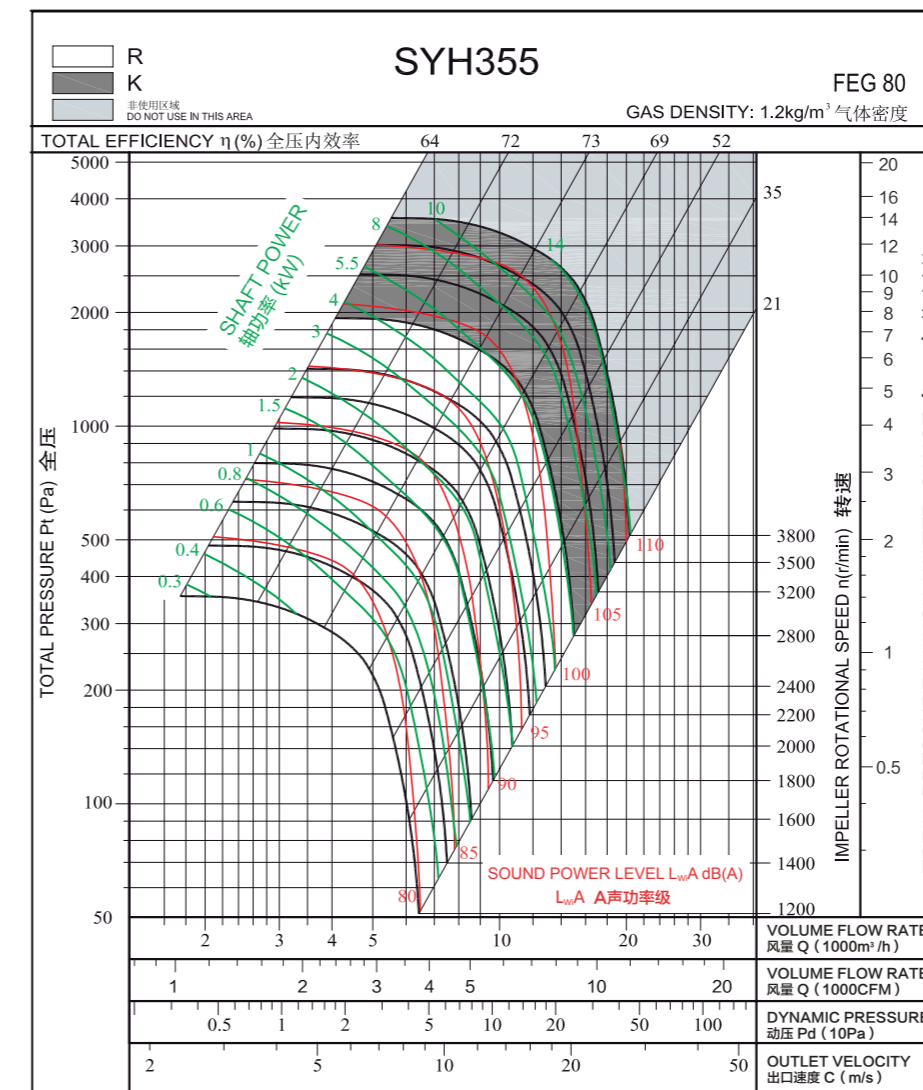

Measured in installation B according to AMCA Standard 210:

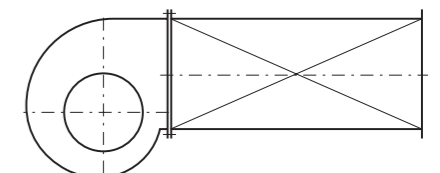

技术参数

Technical Data

Wheel diameter 叶轮直径	D = 400 mm	Fan weight 风机质量	m = 63.6 kg
Moment of inertia 转动惯量	J = 0.38 kg·m ²	Speed limit 极限转速	n _{max} = 4500 r/min

技术参数

Technical Data

Wheel diameter 叶轮直径	D = 450 mm	Fan weight 风机质量	m = 54.7 kg
Moment of inertia 转动惯量	J = 0.66 kg·m ²	Speed limit 极限转速	n _{max} = 2800 r/min

性能曲线

Performance Curve

经认证的性能是B类安装：自由入口，管道出口。功率额定值(kW)不包括传输损失。各项性能额定值不包括附属物(附件)的影响。所示A加权声音性能额定值已按AMCA International标准301计算。所示值为安装类型B：自由入口，管道出口的声功率级（入口L_{WA}）。

Performance certified is for installation type B: free inlet, ducted outlet. Power rating (kW) does not include transmission losses. Performance ratings do not include the effects of appurtenances (accessories). The A-weighted sound ratings shown have been calculated per AMCA International Standard 301. Values shown are for inlet L_{WA} sound power levels for installation type B: free inlet, ducted outlet.

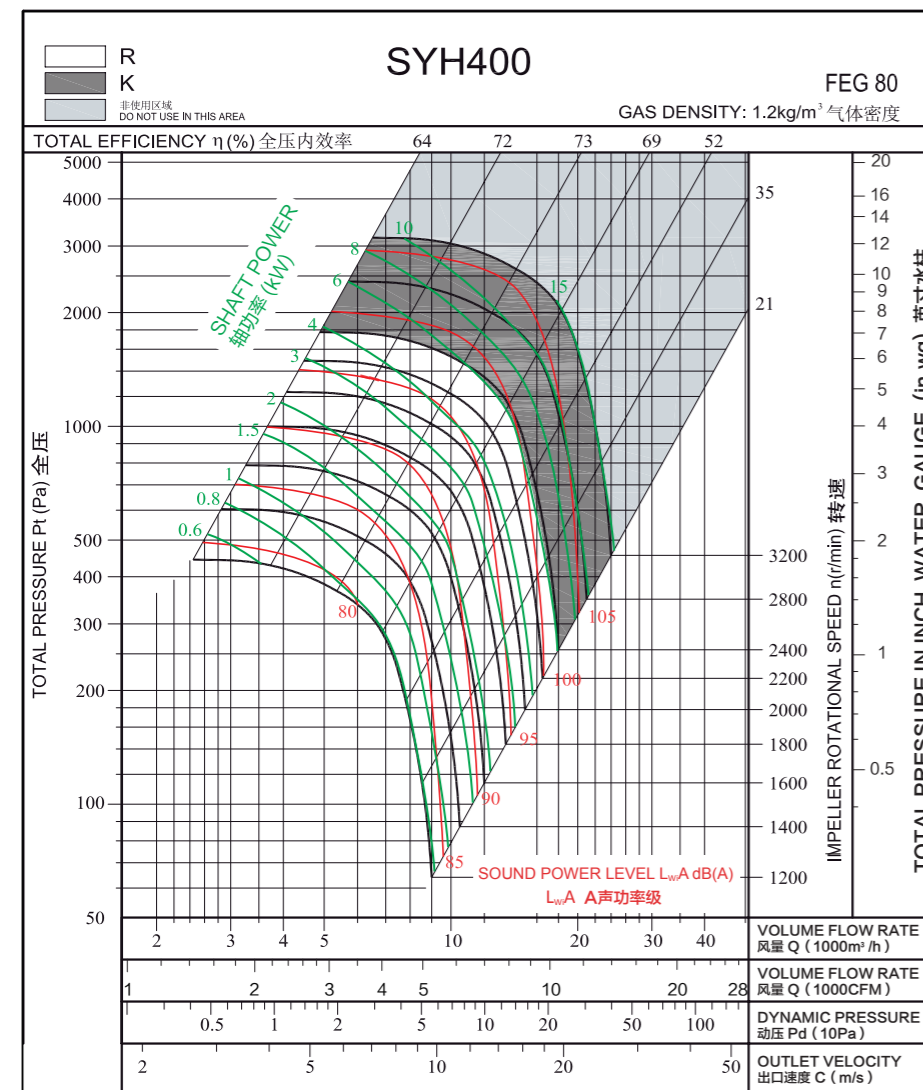

Measured in installation B according to AMCA Standard 210:

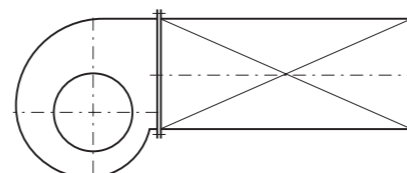

性能曲线

Performance Curve

经认证的性能是B类安装：自由入口，管道出口。功率额定值(kW)不包括传输损失。各项性能额定值不包括附属物(附件)的影响。所示A加权声音性能额定值已按AMCA International标准301计算。所示值为安装类型B：自由入口，管道出口的声功率级（入口L_{WA}）。

Performance certified is for installation type B: free inlet, ducted outlet. Power rating (kW) does not include transmission losses. Performance ratings do not include the effects of appurtenances (accessories). The A-weighted sound ratings shown have been calculated per AMCA International Standard 301. Values shown are for inlet L_{WA} sound power levels for installation type B: free inlet, ducted outlet.

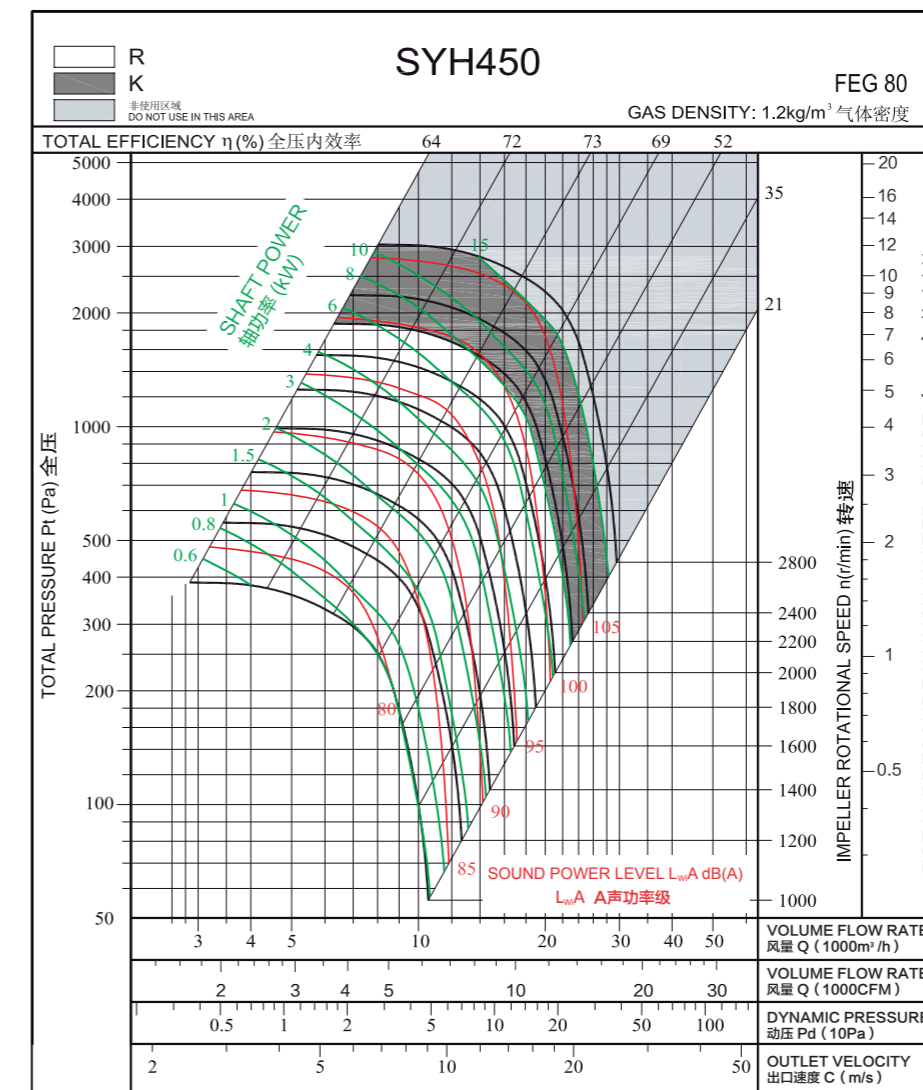

Measured in installation B according to AMCA Standard 210:

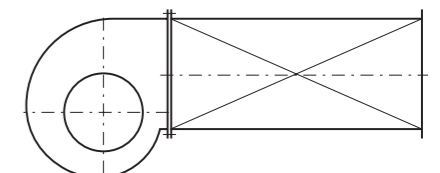

技术参数

Technical Data

Wheel diameter 叶轮直径	D = 500 mm	Fan weight 风机质量	m = 104.2 kg
Moment of inertia 转动惯量	J = 0.95 kgm ²	Speed limit 极限转速	n _{max} = 2800 r/min

技术参数

Technical Data

Wheel diameter 叶轮直径	D = 560 mm	Fan weight 风机质量	m = 171 kg
Moment of inertia 转动惯量	J = 1.8 kgm ²	Speed limit 极限转速	n _{max} = 2500 r/min

性能曲线

Performance Curve

经认证的性能是B类安装：自由入口，管道出口。功率额定值(kW)不包括传输损失。各项性能额定值不包括附属物(附件)的影响。所示A加权声音性能额定值已按AMCA International标准301计算。所示值为安装类型B：自由入口，管道出口的声功率级（入口L_{WA}）。

Performance certified is for installation type B: free inlet, ducted outlet. Power rating (kW) does not include transmission losses. Performance ratings do not include the effects of appurtenances (accessories). The A-weighted sound ratings shown have been calculated per AMCA International Standard 301. Values shown are for inlet L_{WA} sound power levels for installation type B: free inlet, ducted outlet.

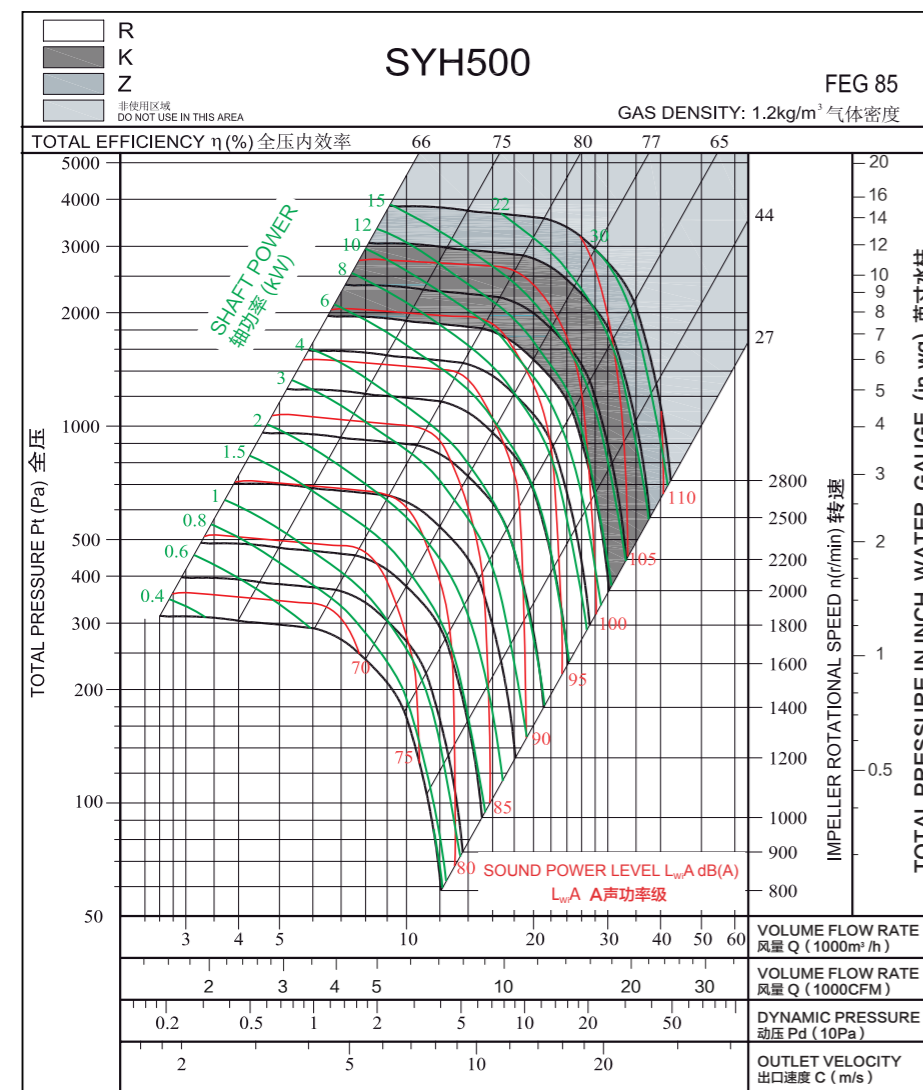

Measured in installation B according to AMCA Standard 210:

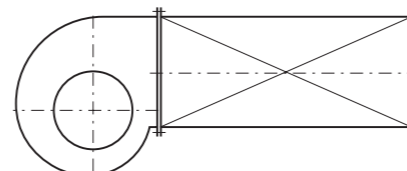

性能曲线

Performance Curve

经认证的性能是B类安装：自由入口，管道出口。功率额定值(kW)不包括传输损失。各项性能额定值不包括附属物(附件)的影响。所示A加权声音性能额定值已按AMCA International标准301计算。所示值为安装类型B：自由入口，管道出口的声功率级（入口L_{WA}）。

Performance certified is for installation type B: free inlet, ducted outlet. Power rating (kW) does not include transmission losses. Performance ratings do not include the effects of appurtenances (accessories). The A-weighted sound ratings shown have been calculated per AMCA International Standard 301. Values shown are for inlet L_{WA} sound power levels for installation type B: free inlet, ducted outlet.

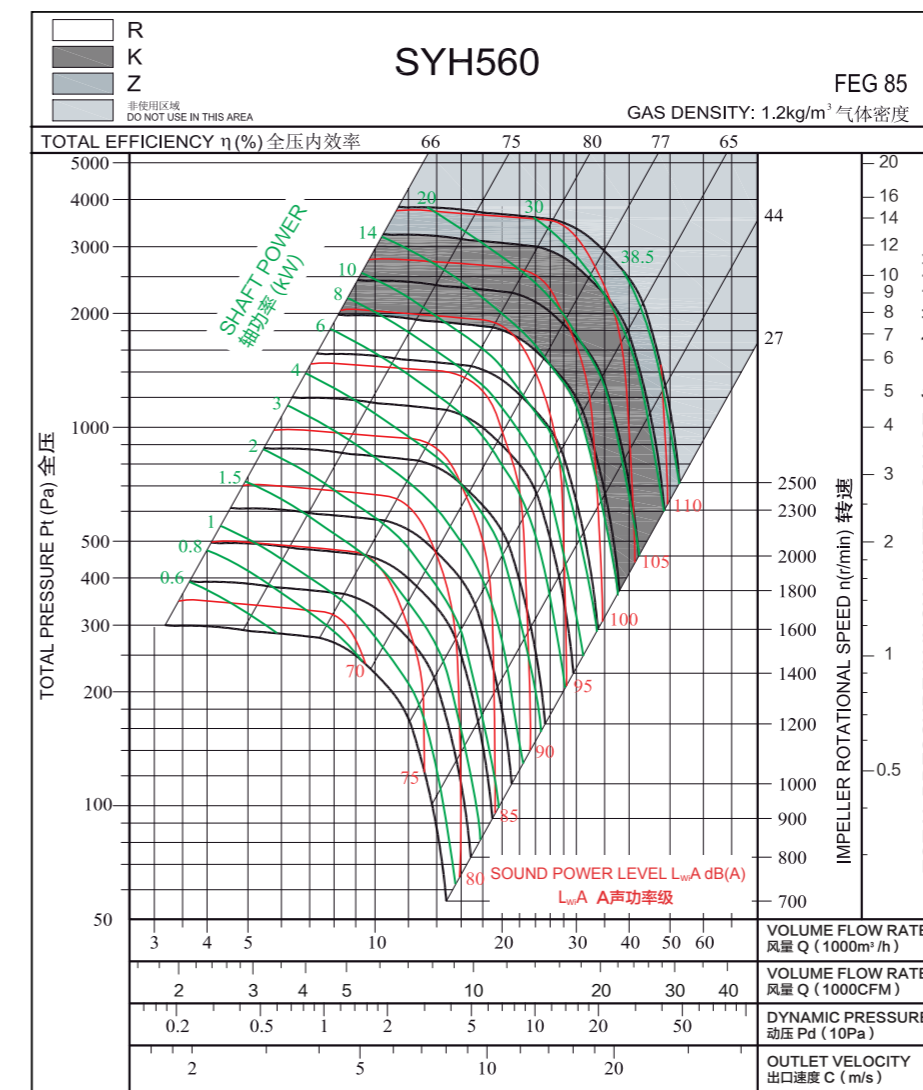

Measured in installation B according to AMCA Standard 210:

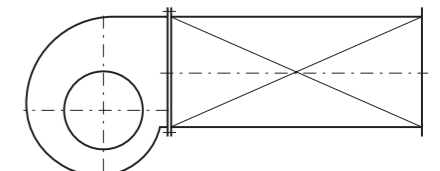

技术参数

Technical Data

Wheel diameter 叶轮直径	D = 630 mm	Fan weight 风机质量	m = 197 kg
Moment of inertia 转动惯量	J = 2.9 kg m ²	Speed limit 极限转速	n _{max} = 2200 r/min

技术参数

Technical Data

Wheel diameter 叶轮直径	D = 710 mm	Fan weight 风机质量	m = 271 kg
Moment of inertia 转动惯量	J = 5.8 kgm ²	Speed limit 极限转速	n _{max} = 2000 r/min

性能曲线

Performance Curve

经认证的性能是B类安装：自由入口，管道出口。功率额定值(kW)不包括传输损失。各项性能额定值不包括附属物(附件)的影响。所示A加权声音性能额定值已按AMCA International标准301计算。所示值为安装类型B：自由入口，管道出口的声功率级（入口L_{wA}）。

Performance certified is for installation type B: free inlet, ducted outlet. Power rating (kW) does not include transmission losses. Performance ratings do not include the effects of appurtenances (accessories). The A-weighted sound ratings shown have been calculated per AMCA International Standard 301. Values shown are for inlet L_{wA} sound power levels for installation type B: free inlet, ducted outlet.

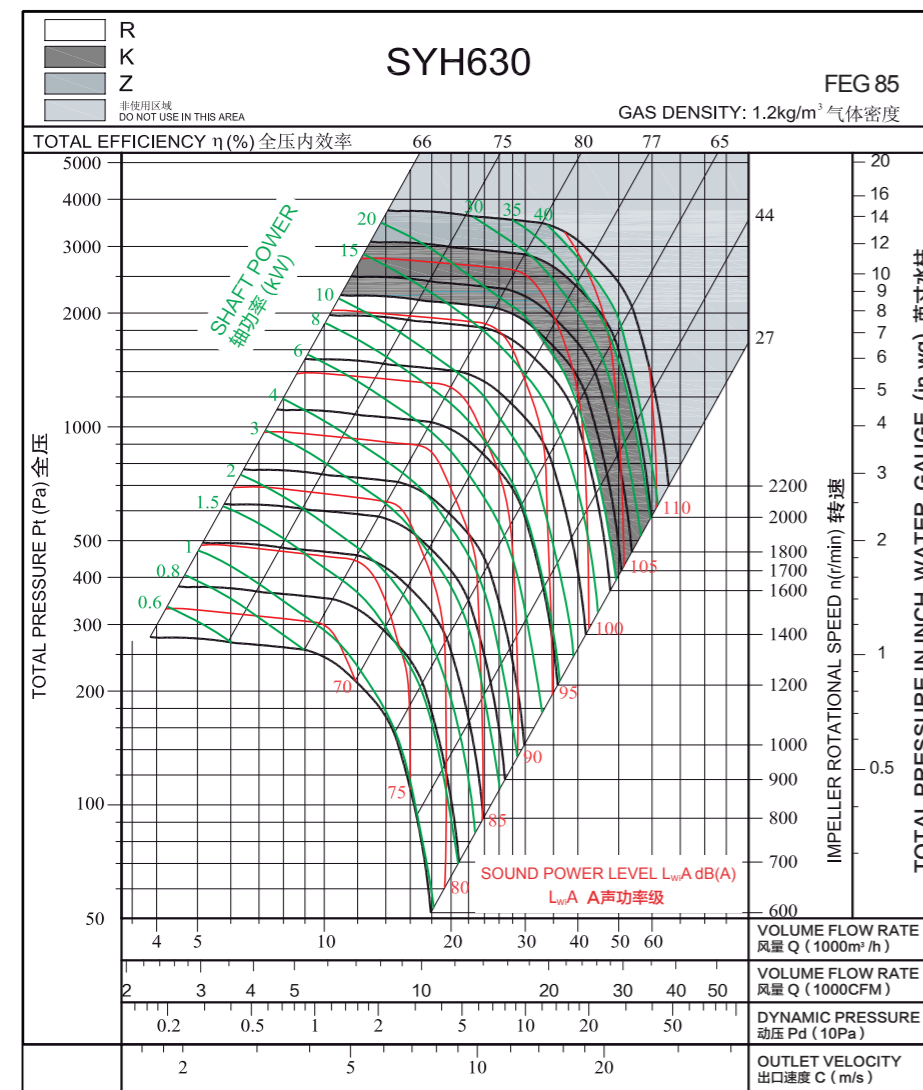

Measured in installation B according to AMCA Standard 210:

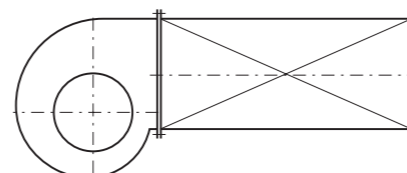

性能曲线

Performance Curve

经认证的性能是B类安装：自由入口，管道出口。功率额定值(kW)不包括传输损失。各项性能额定值不包括附属物(附件)的影响。所示A加权声音性能额定值已按AMCA International标准301计算。所示值为安装类型B：自由入口，管道出口的声功率级（入口L_{wA}）。

Performance certified is for installation type B: free inlet, ducted outlet. Power rating (kW) does not include transmission losses. Performance ratings do not include the effects of appurtenances (accessories). The A-weighted sound ratings shown have been calculated per AMCA International Standard 301. Values shown are for inlet L_{wA} sound power levels for installation type B: free inlet, ducted outlet.

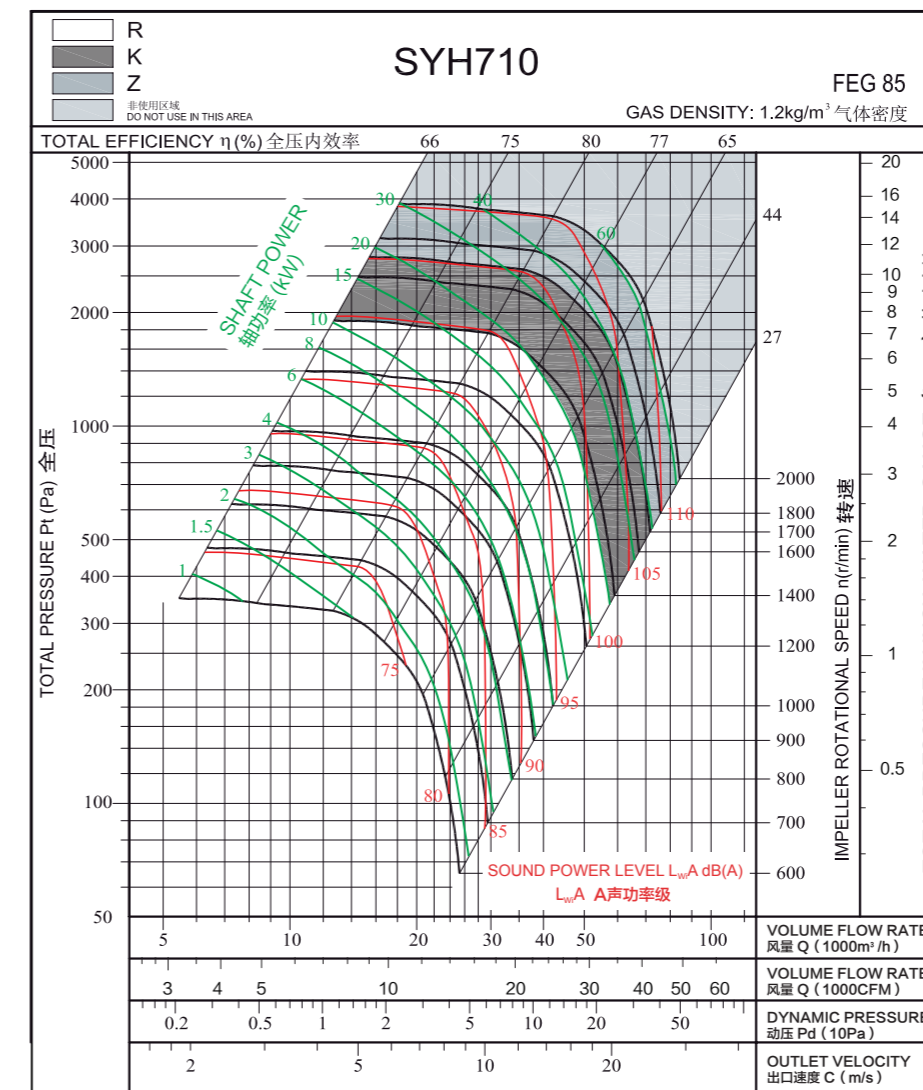

Measured in installation B according to AMCA Standard 210:

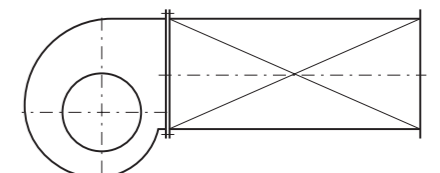

技术参数

Technical Data

Wheel diameter 叶轮直径	D = 800 mm	Fan weight 风机质量	m = 300 kg
Moment of inertia 转动惯量	J = 10.35 kgm ²	Speed limit 极限转速	n _{max} = 1600 r/min

技术参数

Technical Data

Wheel diameter 叶轮直径	D = 900 mm	Fan weight 风机质量	m = 481.5 kg
Moment of inertia 转动惯量	J = 15.5 kgm ²	Speed limit 极限转速	n _{max} = 1400 r/min

性能曲线

Performance Curve

经认证的性能是B类安装：自由入口，管道出口。功率额定值(kW)不包括传输损失。各项性能额定值不包括附属物(附件)的影响。所示A加权声音性能额定值已按AMCA International标准301计算。所示值为安装类型B：自由入口，管道出口的声功率级（入口L_{WA}）。

Performance certified is for installation type B: free inlet, ducted outlet. Power rating (kW) does not include transmission losses. Performance ratings do not include the effects of appurtenances (accessories). The A-weighted sound ratings shown have been calculated per AMCA International Standard 301. Values shown are for inlet L_{WA} sound power levels for installation type B: free inlet, ducted outlet.

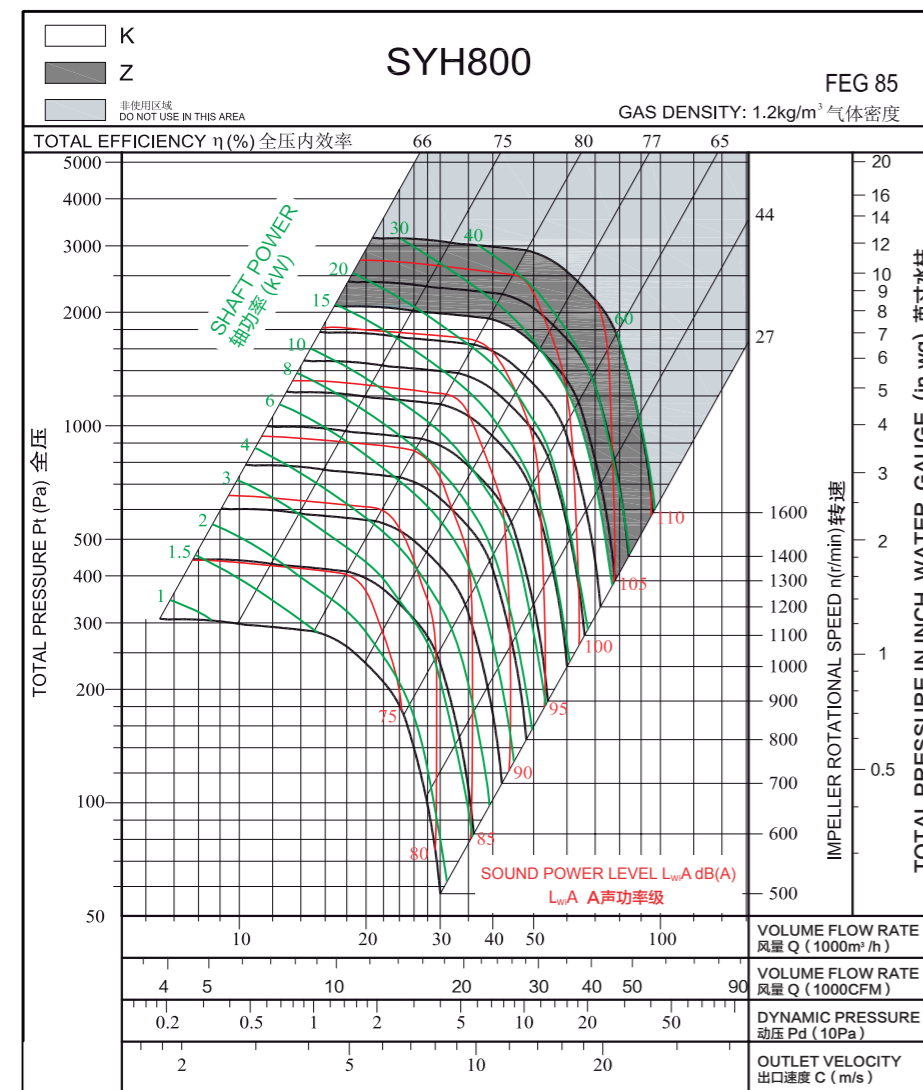

Measured in installation B according to AMCA Standard 210:

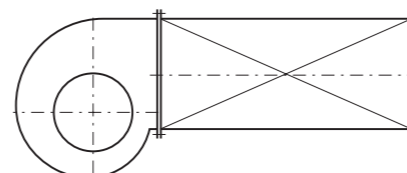

性能曲线

Performance Curve

经认证的性能是B类安装：自由入口，管道出口。功率额定值(kW)不包括传输损失。各项性能额定值不包括附属物(附件)的影响。所示A加权声音性能额定值已按AMCA International标准301计算。所示值为安装类型B：自由入口，管道出口的声功率级（入口L_{WA}）。

Performance certified is for installation type B: free inlet, ducted outlet. Power rating (kW) does not include transmission losses. Performance ratings do not include the effects of appurtenances (accessories). The A-weighted sound ratings shown have been calculated per AMCA International Standard 301. Values shown are for inlet L_{WA} sound power levels for installation type B: free inlet, ducted outlet.

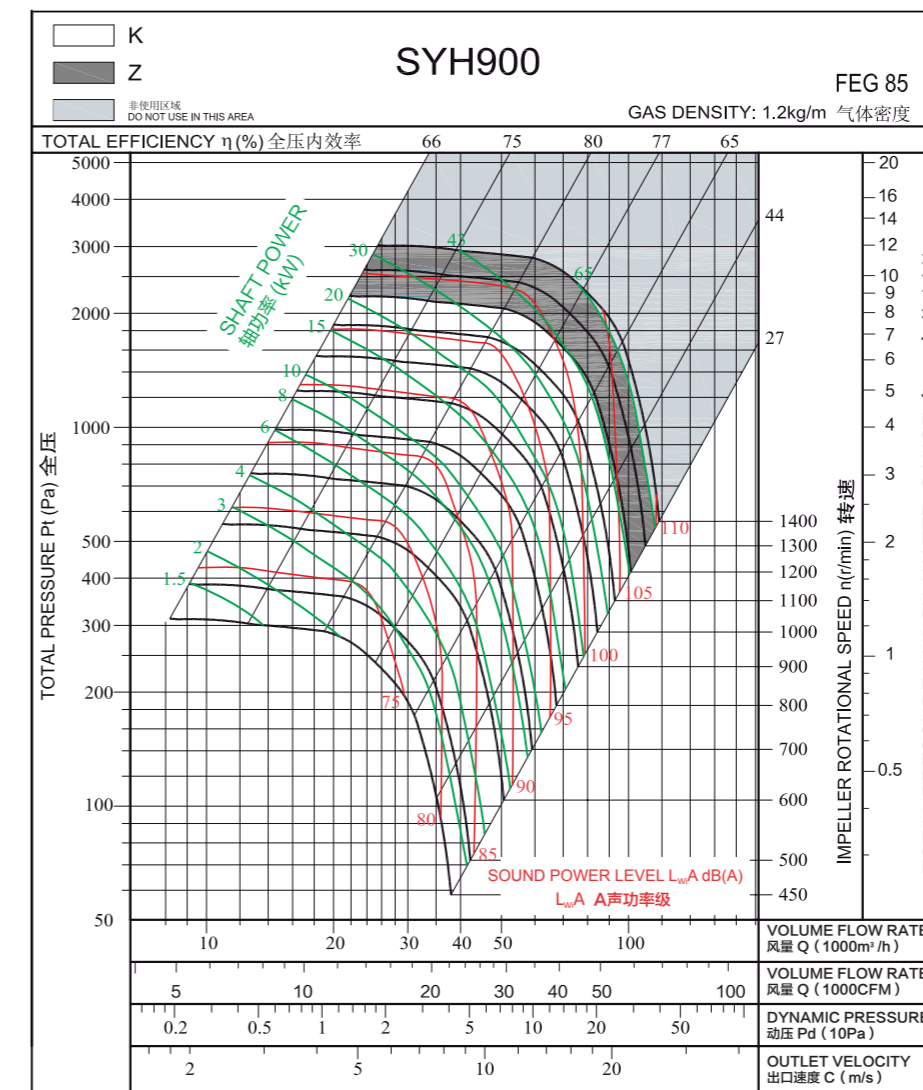

Measured in installation B according to AMCA Standard 210:

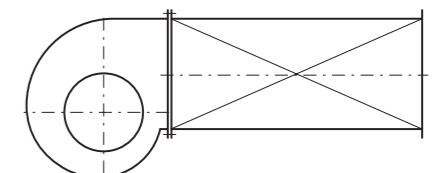

技术参数

Technical Data

Wheel diameter 叶轮直径	D = 1000 mm	Fan weight 风机质量	m = 530 kg
Moment of inertia 转动惯量	J = 26.7 kgm ²	Speed limit 极限转速	n _{max} = 1300 r/min

技术参数

Technical Data

Wheel diameter 叶轮直径	D = 1120 mm	Fan weight 风机质量	m = 820 kg
Moment of inertia 转动惯量	J = 47.6 kgm ²	Speed limit 极限转速	n _{max} = 1450 r/min

性能曲线

Performance Curve

经认证的性能是B类安装：自由入口，管道出口。功率额定值(kW)不包括传输损失。各项性能额定值不包括附属物(附件)的影响。所示A加权声音性能额定值已按AMCA International标准301计算。所示值为安装类型B：自由入口，管道出口的声功率级（入口L_{wA}）。

Performance certified is for installation type B: free inlet, ducted outlet. Power rating (kW) does not include transmission losses. Performance ratings do not include the effects of appurtenances (accessories). The A-weighted sound ratings shown have been calculated per AMCA International Standard 301. Values shown are for inlet L_{wA} sound power levels for installation type B: free inlet, ducted outlet.

性能曲线

Performance Curve

经认证的性能是B类安装：自由入口，管道出口。功率额定值(kW)不包括传输损失。各项性能额定值不包括附属物(附件)的影响。所示A加权声音性能额定值已按AMCA International标准301计算。所示值为安装类型B：自由入口，管道出口的声功率级（入口L_{wA}）。

Performance certified is for installation type B: free inlet, ducted outlet. Power rating (kW) does not include transmission losses. Performance ratings do not include the effects of appurtenances (accessories). The A-weighted sound ratings shown have been calculated per AMCA International Standard 301. Values shown are for inlet L_{wA} sound power levels for installation type B: free inlet, ducted outlet.

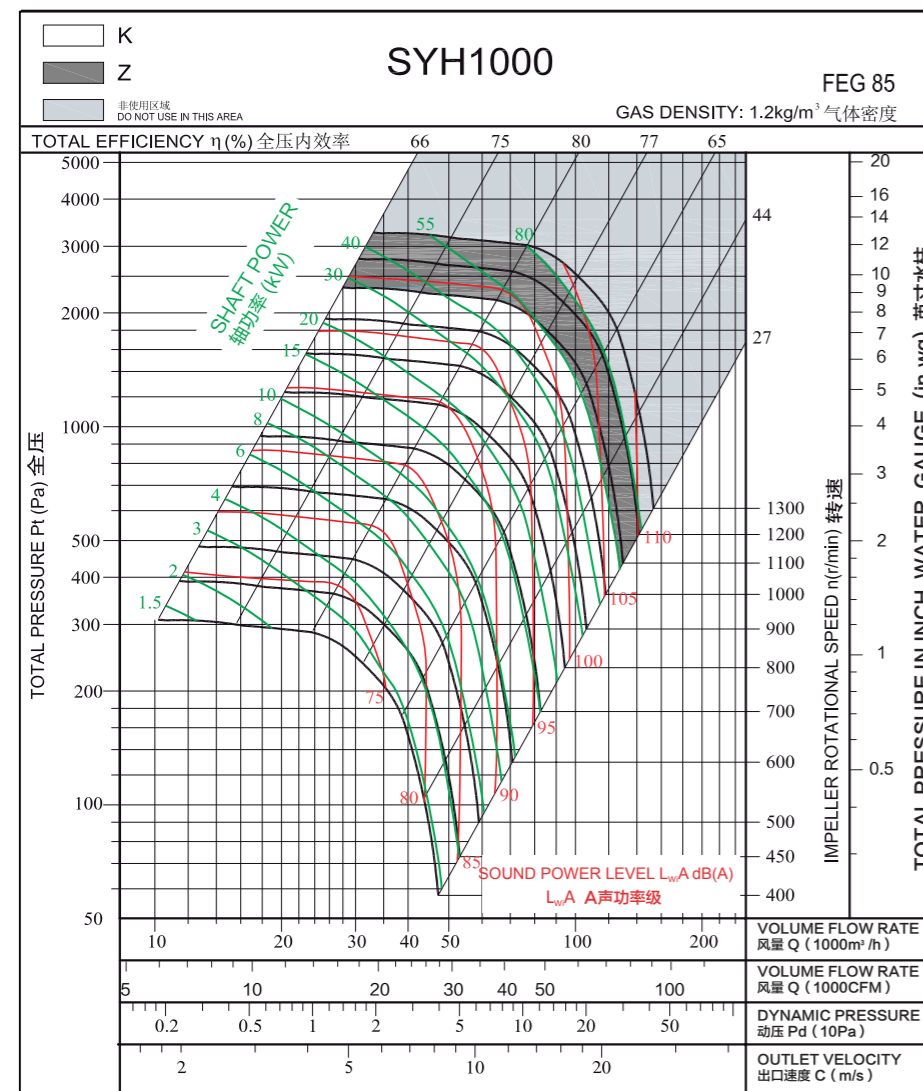

Measured in installation B according to AMCA Standard 210:

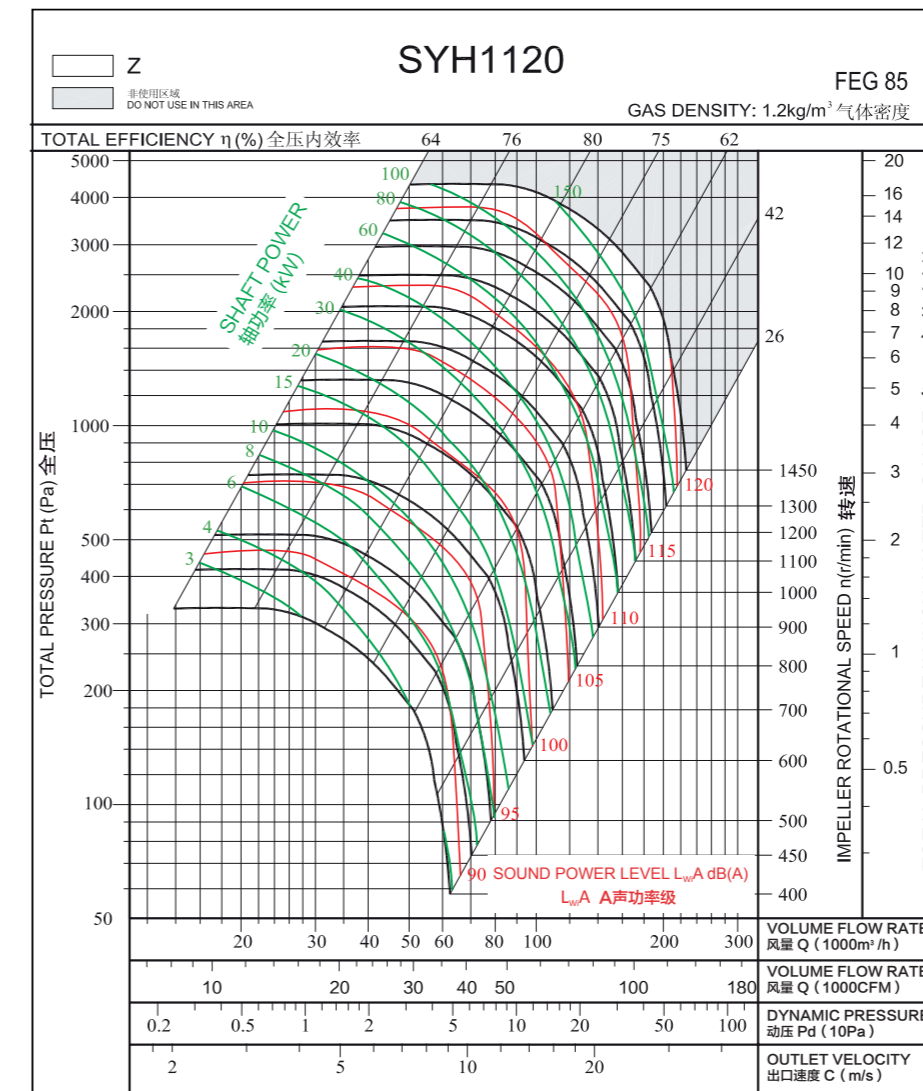
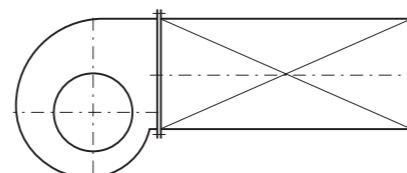

Measured in installation B according to AMCA Standard 210:

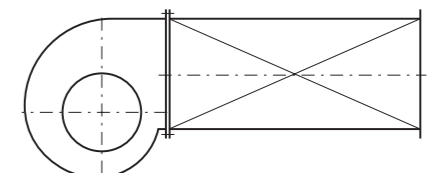

技术参数

Technical Data

Wheel diameter 叶轮直径	D = 1250 mm	Fan weight 风机质量	m = 1140 kg
Moment of inertia 转动惯量	J = 80.7 kgm ²	Speed limit 极限转速	n _{max} = 1300 r/min

技术参数

Technical Data

Wheel diameter 叶轮直径	D = 1400 mm	Fan weight 风机质量	m = 1460 kg
Moment of inertia 转动惯量	J = 156.9 kgm ²	Speed limit 极限转速	n _{max} = 1150 r/min

性能曲线

Performance Curve

经认证的性能是B类安装：自由入口，管道出口。功率额定值(kW)不包括传输损失。各项性能额定值不包括附属物(附件)的影响。所示A加权声音性能额定值已按AMCA International标准301计算。所示值为安装类型B：自由入口，管道出口的声功率级（入口L_{WA}）。

Performance certified is for installation type B: free inlet, ducted outlet. Power rating (kW) does not include transmission losses. Performance ratings do not include the effects of appurtenances (accessories). The A-weighted sound ratings shown have been calculated per AMCA International Standard 301. Values shown are for inlet L_{WA} sound power levels for installation type B: free inlet, ducted outlet.

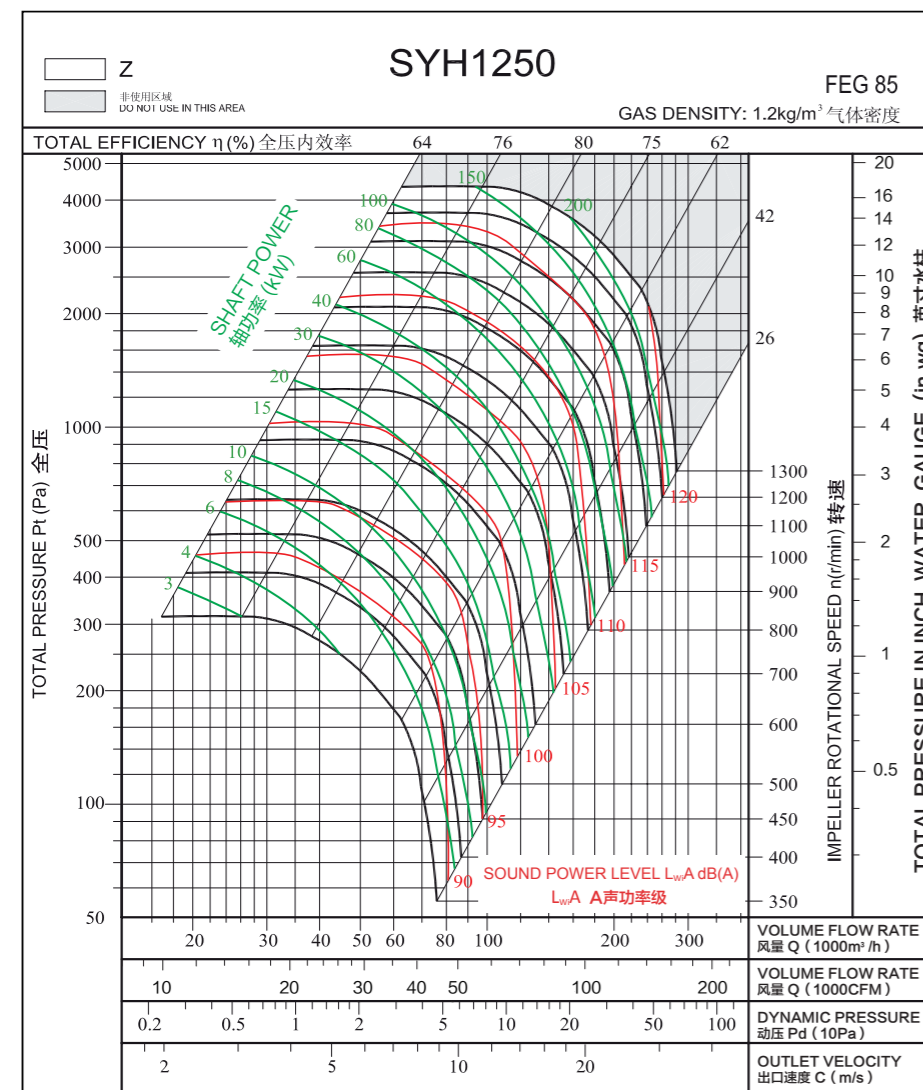

Measured in installation B according to AMCA Standard 210:

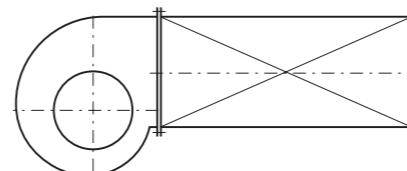

性能曲线

Performance Curve

经认证的性能是B类安装：自由入口，管道出口。功率额定值(kW)不包括传输损失。各项性能额定值不包括附属物(附件)的影响。所示A加权声音性能额定值已按AMCA International标准301计算。所示值为安装类型B：自由入口，管道出口的声功率级（入口L_{WA}）。

Performance certified is for installation type B: free inlet, ducted outlet. Power rating (kW) does not include transmission losses. Performance ratings do not include the effects of appurtenances (accessories). The A-weighted sound ratings shown have been calculated per AMCA International Standard 301. Values shown are for inlet L_{WA} sound power levels for installation type B: free inlet, ducted outlet.

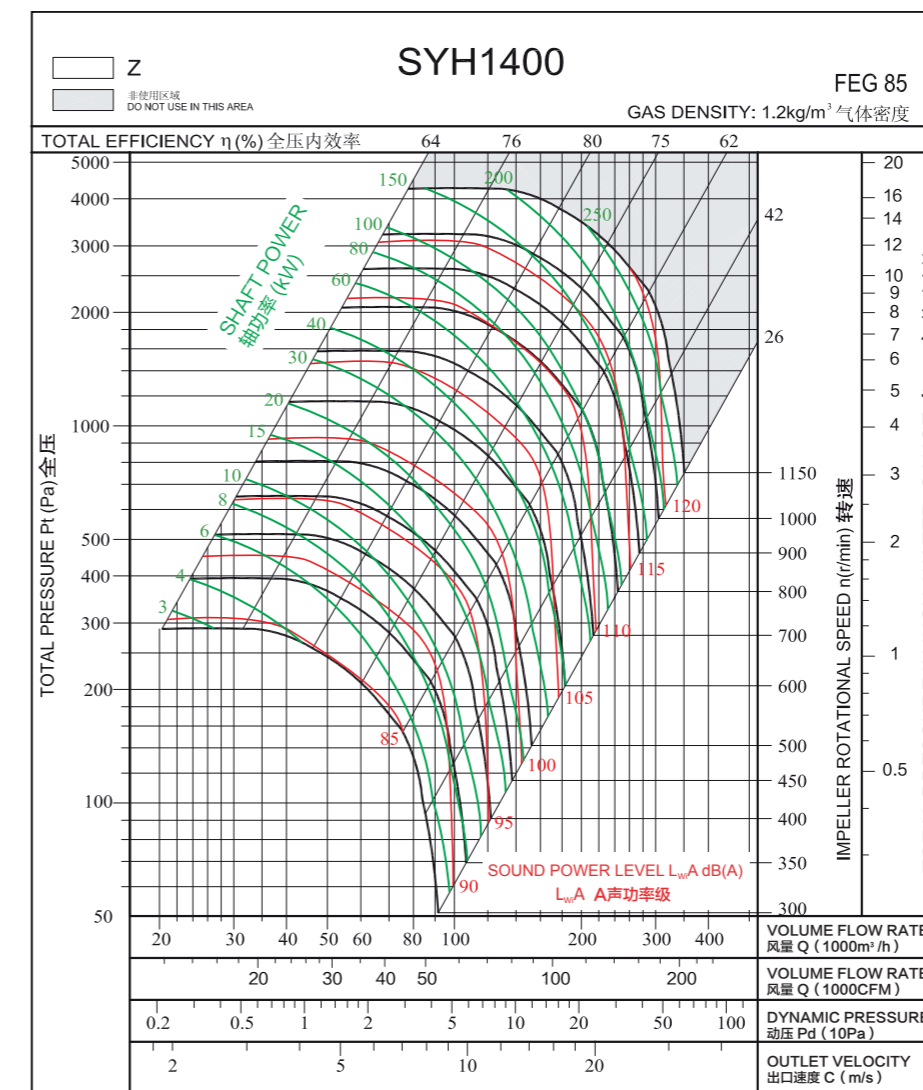

Measured in installation B according to AMCA Standard 210:

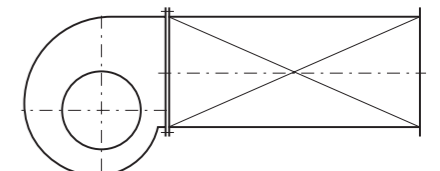

技术参数

Technical Data

Wheel diameter 叶轮直径	D = 1600 mm	Fan weight 风机质量	m = 1820 kg
Moment of inertia 转动惯量	J = 260.8 kgm ²	Speed limit 极限转速	n _{max} = 1000 r/min

出口法兰

Outlet Flange

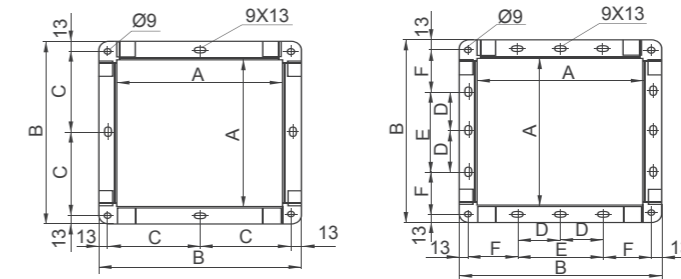

性能曲线

Performance Curve

经认证的性能是B类安装：自由入口，管道出口。功率额定值(kW)不包括传输损失。各项性能额定值不包括附属物(附件)的影响。所示A加权声音性能额定值已按AMCA International标准301计算。所示值为安装类型B：自由入口，管道出口的声功率级（入口L_{wA}）。

Performance certified is for installation type B: free inlet, ducted outlet. Power rating (kW) does not include transmission losses. Performance ratings do not include the effects of appurtenances (accessories). The A-weighted sound ratings shown have been calculated per AMCA International Standard 301. Values shown are for inlet L_{wA} sound power levels for installation type B: free inlet, ducted outlet.

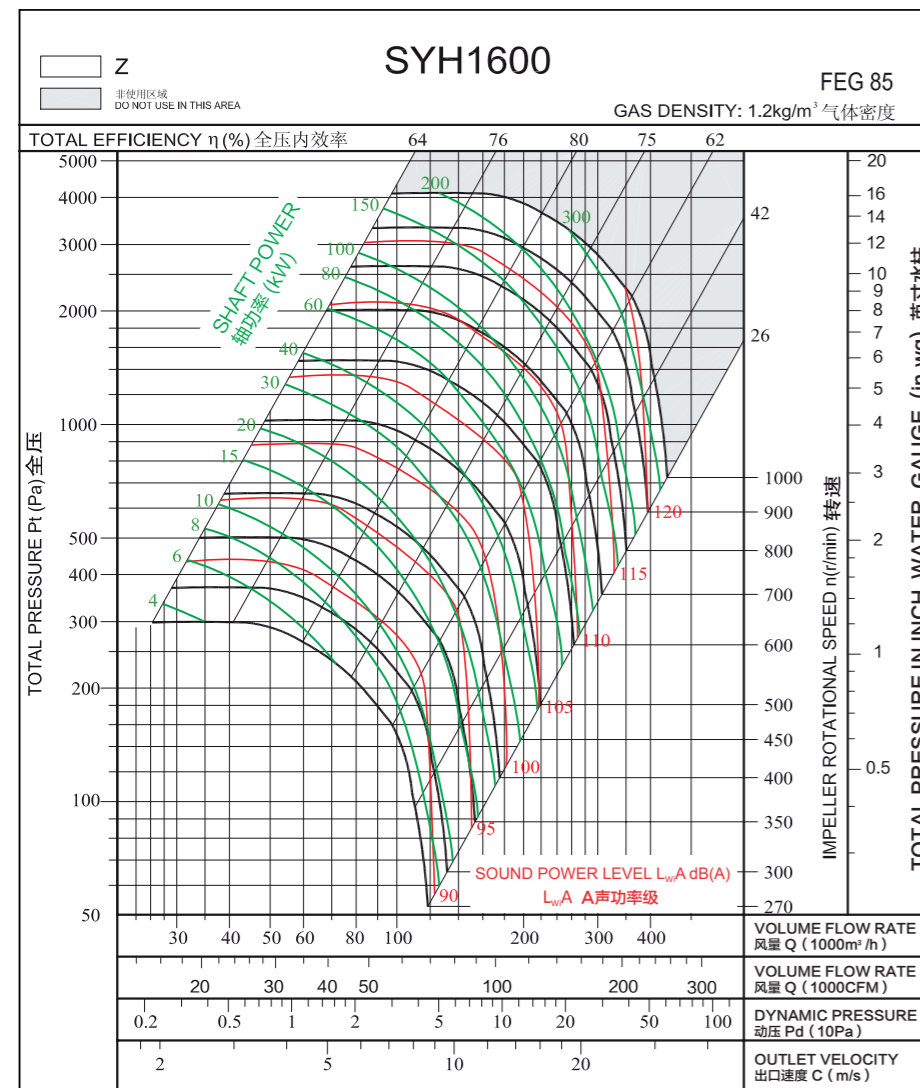

Measured in installation B according to AMCA Standard 210:



图2 (Fig 2)

单位: mm

Model Dim	280	315	355	400	450	500	560	630	710	800	900	1000
A	361	404	453	507	569	638	715	801	898	1007	1130	1267
B	417	460	509	563	625	694	771	857	954	1063	1186	1323
C	195.5	217	241.5	-	-	-	-	-	-	-	-	-
D	-	-	-	-	-	-	-	-	200	250	300	350
E	-	-	-	200	200	250	250	300	400	500	600	700
F	-	-	-	168.5	199.5	209	207.5	265.5	264	268.5	280	298.5

出口法兰

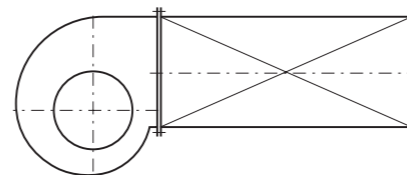
Outlet Flange



图2 (Fig 2)

单位: mm

Model Dim	1120	1250	1400	1600
A	1426	1588	1776	2027
B	1349	1494	1687	1900
C	1526	1688	1876	2127
D	1449	1594	1787	2000
E	1476	1638	1826	2077
F	1399	1544	1737	1950
n-ØD	16-Ø15	16-Ø15	26-Ø15	24-Ø15

SYH-R

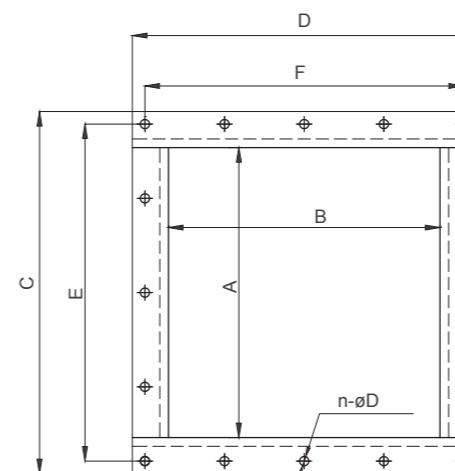
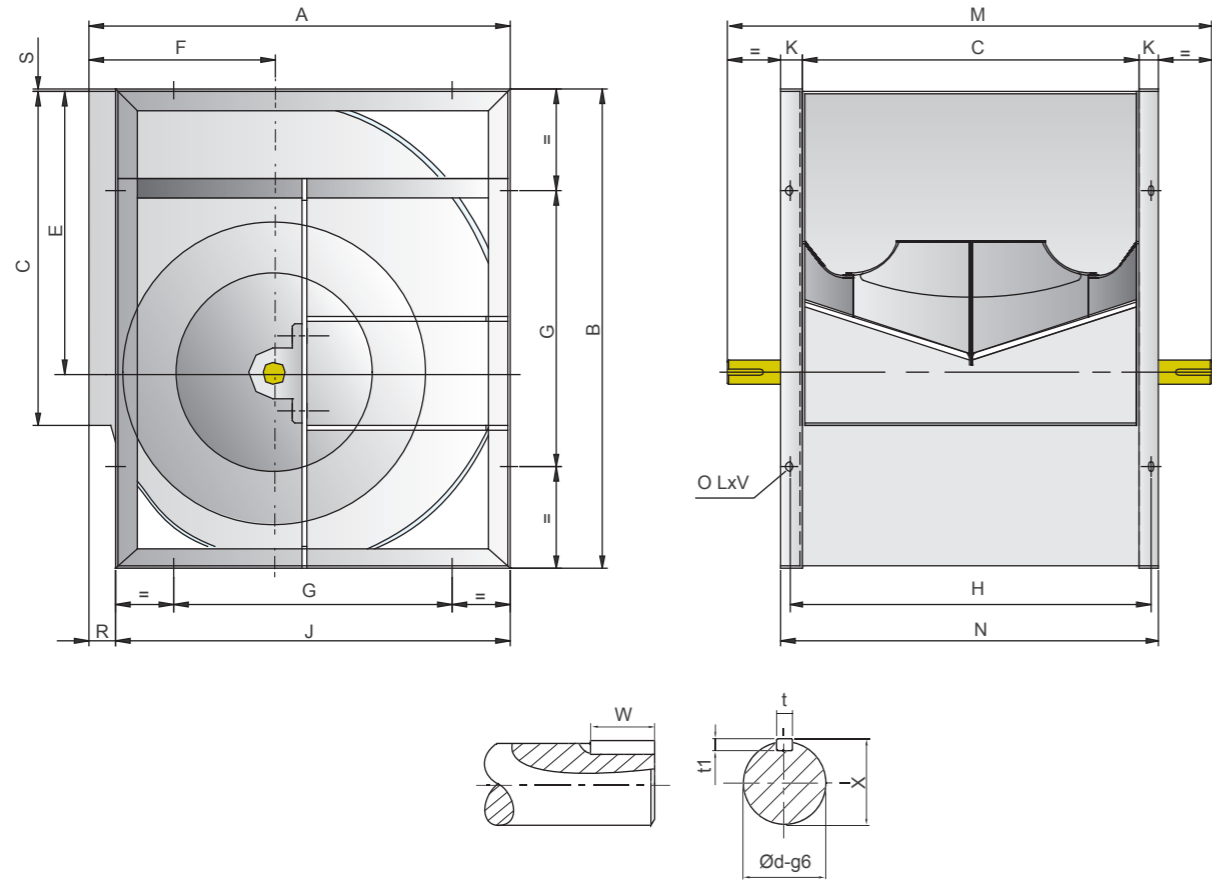

单位: mm

Model Dim	A	B	C	E	F	G	H	J	K	M	N	R	S	t	t1	W	X	Ød	LxV
280	466	518	361	302	215	280	391	432	30	575	421	34	5	8	7	50	28	25	13x18
315	518	578	404	340	236	280	434	480	30	640	464	38	3	8	7	60	28	25	13x18
355	578	655	453	383	261	355	493	548	40	700	533	30	6	8	7	60	33	30	13x18
400	651	736	507	432	290	355	547	613	40	760	587	38	5	8	7	60	33	30	13x18
450	726	827	569	486	322	530	609	681	40	845	649	45	5	10	8	70	38	35	13x18
500	800	918	638	538	352	530	678	750	40	915	718	50	5	10	8	70	38	35	13x18
560	893	1030	715	603	390	530	765	845	50	1000	815	48	8	12	8	70	43	40	13x18
630	999	1157	801	679	434	530	851	946	50	1090	901	53	7	14	9	70	49	45	13x18
710	1121	1303	898	765	485	630	948	1058	50	1255	998	63	7	14	9	90	54	50	17x22

SYH-K(Z)

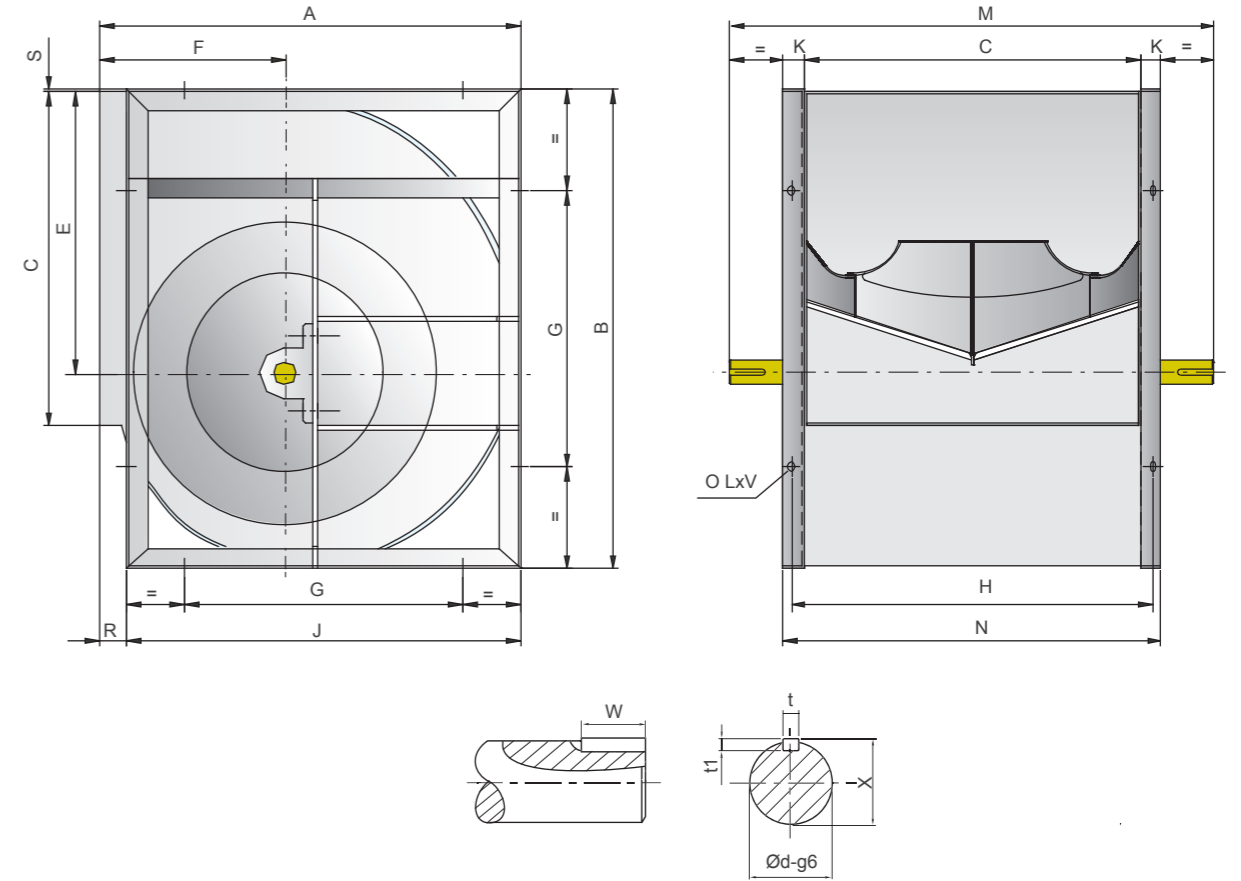

单位: mm

Model Dim	A	B	C	E	F	G	H	J	K	M	N	R	S	t	t1	W	X	Ød	LxV
280	466	518	361	302	215	280	391	432	30	600	421	34	5	8	7	60	33	30	13x18
315	518	578	404	340	236	280	434	480	30	665	464	38	3	8	7	70	33	30	13x18
355	578	655	453	383	261	355	493	548	40	725	533	30	6	10	8	70	38	35	13x18
400	651	736	507	432	290	355	547	613	40	790	587	38	5	10	8	70	38	35	13x18
450	726	827	569	486	322	530	609	681	40	890	649	45	5	12	8	90	43	40	13x18
500	800	918	638	538	352	530	678	750	40	960	718	50	5	12	8	90(70)	43	40	13x18
560	893	1030	715	603	390	530	765	845	50	1070	815	48	8	14	9	90(70)	54	50	13x18
630	899	1157	801	679	434	530	851	946	50	1155	901	53	7	14	9	90(70)	54	50	13x18
710	1121	1303	898	765	485	630	948	1058	50	1290	998	63	7	18	11	90	64	60	17x22
800	1250	1468	1007	862	535	710	1057	1181	50	1450	1107	69	7	18	11	90	64	60	17x22
900	1408	1648	1130	971	604	800	1180	1319	60	1570	1250	89	7	18	11	100	69	65	17x22
1000	1541	1810	1267	1066	657	900	1317	1462	60	1700	1387	79	9	18	11	100	69	65	17x22

SYH-Z

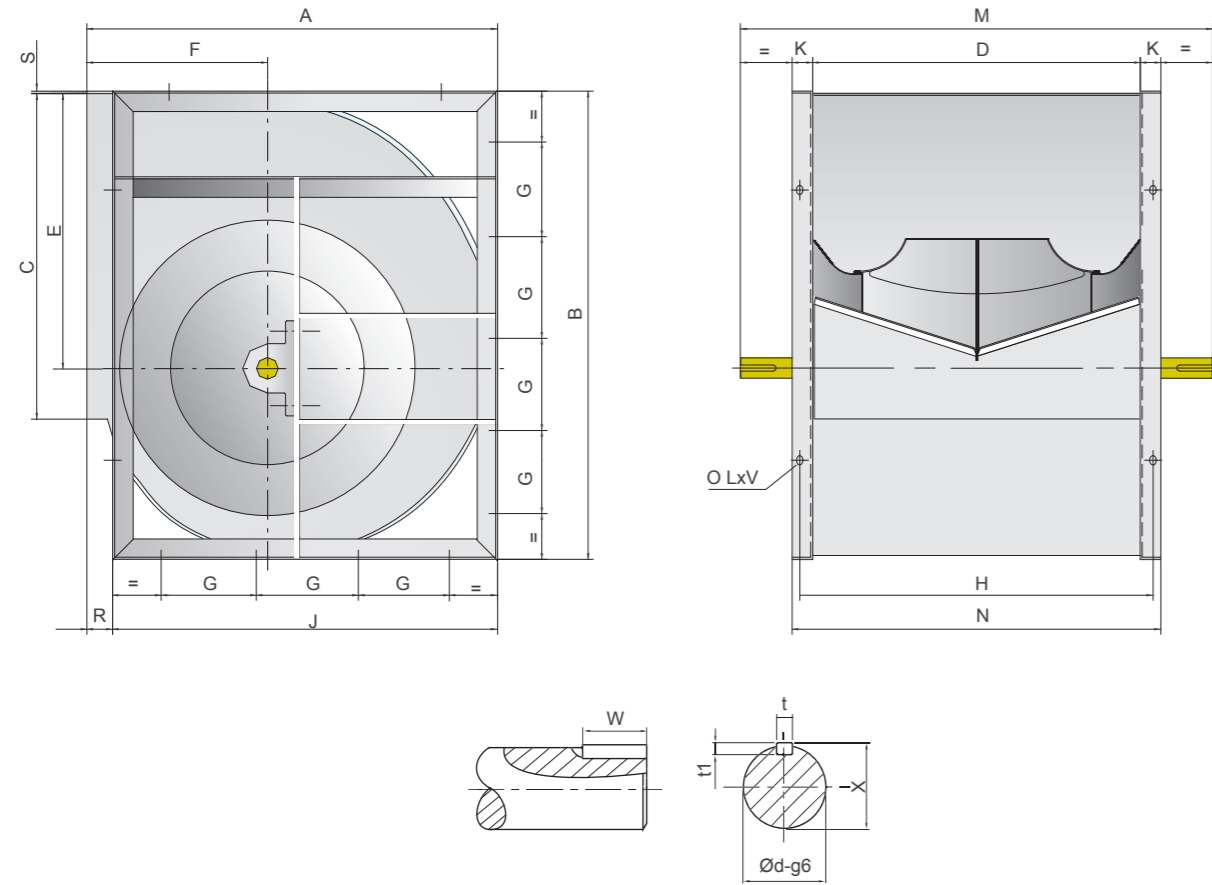

单位: mm

Model Dim	A	B	C	D	E	F	G	H	J	K	M	N	R	S	t	t1	W	X	Ød	LxV
1120	1748	2033	1423	1346	1194	758	400	1406	1630	60	1960	1466	118	9	20	12	140	80	75	17x22
1250	1950	2270	1588	1494	1333	840	450	1574	1825	75	2115	1644	125	12	22	14	140	85	80	17x22
1400	2160	2535	1774	1685	1492	920	500	1765	2050	75	2250	1835	110	10	22	14	140	90	85	17x22
1600	2468	2897	2027	1900	1705	1050	570	1975	2345	75	2650	2050	123	11	25	14	140	100	95	17x22

SYH-R(K)2

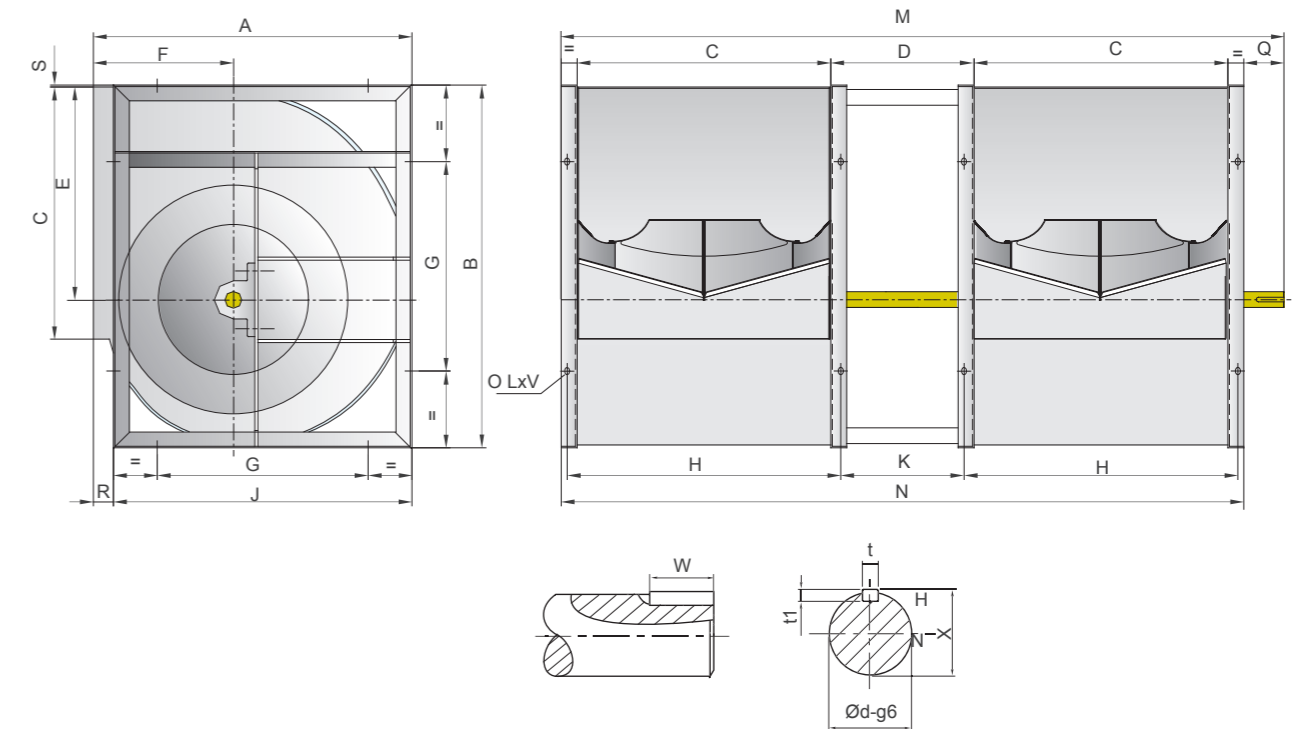

单位: mm

Model Dim	A	B	C	D	E	F	G	H	J	K	M	N	Q	R	S	t	t1	W	X	Ød	LxV
280	466	518	361	280	302	215	280	391	432	250	1165	1062	103	34	5	8	7	60	28	25	13x18
315	518	578	404	315	340	236	280	434	480	285	1286	1183	103	38	3	8	7	60	33	30	13x18
355	578	655	453	355	383	261	355	493	548	315	1442	1340	101	30	6	10	8	60	38	35	13x18
400	651	736	507	400	432	290	355	547	613	360	1610	1494	116	38	5	12	8	60	43	40	13x18
450	726	827	569	450	486	322	530	609	681	410	1782	1668	114	45	5	12	8	70	43	40	13x18
500	800	918	638	500	538	352	530	678	750	460	1977	1856	121	50	5	14	9	70	49	40	13x18

SYH-K2

单位: mm

Model Dim	A	B	C	D	E	F	G	H	J	K	M	N	Q	R	S	t	t1	W	X	Ød	LxV
355	578	655	453	355	383	261	355	493	548	315	1442	1341	101	30	6	12	8	70	43	40	13x18
400	651	736	507	400	432	290	355	547	613	360	1610	1494	116	38	5	14	9	70	49	45	13x18
450	726	827	569	450	486	322	530	609	681	410	1795	1668	127	45	5	14	9	70	49	45	13x18
500	800	918	638	500	538	352	530	678	750	460	1977	1856	121	50	5	14	9	70	54	50	13x18

SYH-R(K)

		0°				90°				180°			
左旋 LG Left Hand													
右旋 RD Right Hand													
型号 Model	电机 机座型号 Motor Frame Size	A	B		C	A	B		C	A	B		C
			R型	K型			R型	K型			R型	K型	
280	71	940	575	600	568	940	575	600	516	940	575	600	568
	80	940	575	600	568	940	575	600	516	940	575	600	568
	90	940	575	600	568	940	575	600	516	940	575	600	568
	100	940	575	600	568	940	575	600	516	940	575	600	568
	112	940	575	600	568	940	575	600	516	940	575	600	568
	132	940	575	600	568	940	575	600	516	940	575	600	568
315	71	1040	640	665	628	1040	640	665	568	1040	640	665	628
	80	1040	640	665	628	1040	640	665	568	1040	640	665	628
	90	1040	640	665	628	1040	640	665	568	1040	640	665	628
	100	1040	640	665	628	1040	640	665	568	1040	640	665	628
	112	1040	640	665	628	1040	640	665	568	1040	640	665	628
	132	1040	640	665	628	1040	640	665	568	1040	640	665	628
355	80	1110	700	725	705	1110	700	725	628	1110	700	725	705
	90	1110	700	725	705	1110	700	725	628	1110	700	725	705
	100	1110	700	725	705	1110	700	725	628	1110	700	725	705
	112	1110	700	725	705	1110	700	725	628	1110	700	725	705
	132	1110	700	725	705	1110	700	725	628	1110	700	725	705
	160	1110	700	725	705	1110	700	725	628	1110	700	725	705
400	180	1250	700	725	705	1250	700	725	628	1250	700	725	705
	90	1250	760	790	786	1250	760	790	701	1250	760	790	786
	100	1250	760	790	786	1250	760	790	701	1250	760	790	786
	112	1250	760	790	786	1250	760	790	701	1250	760	790	786
	132	1250	760	790	786	1250	760	790	701	1250	760	790	786
	160	1250	760	790	786	1250	760	790	701	1250	760	790	786
450	180	1250	760	790	786	1250	760	790	701	1250	760	790	786
	90	1340	845	890	890	1340	845	890	789	1340	845	890	890
	100	1340	845	890	890	1340	845	890	789	1340	845	890	890
	112	1340	845	890	890	1340	845	890	789	1340	845	890	890
	132	1340	845	890	890	1340	845	890	789	1340	845	890	890
	160	1340	845	890	890	1340	845	890	789	1340	845	890	890
500	180	1340	845	890	890	1340	845	890	789	1340	845	890	890
	200	1340	845	890	890	1340	845	890	789	1340	845	890	890
	90	1420	915	960	981	1420	915	960	863	1420	915	960	981
	100	1420	915	960	981	1420	915	960	863	1420	915	960	981
	112	1420	915	960	981	1420	915	960	863	1420	915	960	981
	132	1420	915	960	981	1420	915	960	863	1420	915	960	981

SYH-R(K)

		0°				90°				180°				
左旋 LG Left Hand														
右旋 RD Right Hand														
型号 Model	电机 机座型号 Motor Frame Size	A	B		C	A	B		C	A	B		C	
			R型	K型			R型	K型			R型	K型		
560	90	1580	1000	1070	1093	1580	1000	1070	956	1580	1000	1070	1093	
	100	1580	1000	1070	1093	1580	1000	1070	956	1580	1000	1070	1093	
	112	1580	1000	1070	1093	1580	1000	1070	956	1580	1000	1070	1093	
	132	1580	1000	1070	1093	1580	1000	1070	956	1580	1000	1070	1093	
	160	1580	1000	1070	1093	1580	1000	1070	956	1580	1000	1070	1093	
	180	1580	1000	1070	1093	1580	1000	1070	956	1580	1000	1070	1093	
	200	1580	1000	1070	1093	1580	1000	1070	956	1580	1000	1070	1093	
	630	100	1770	1090	1155	1220	1770	1090	1155	1062	1770	1090	1155	1220
710	112	1770	1090	1155	1220	1770	1090	1155	1062	1770	1090	1155	1220	
	132	1770	1090	1155	1220	1770	1090	1155	1062	1770	1090	1155	1220	
	160	1770	1090	1155	1220	1770	1090	1155	1062	1770	1090	1155	1220	
	180	1770	1090	1155	1220	1770	1090	1155	1062	1770	1090	1155	1220	
	200	1770	1090	1155	1220	1770	1090	1155	1062	1770	1090	1155	1220	
	710	112	1950	1255	1290	1366	1950	1255	1290	1184	1950	1255	1290	1366
800	132	1950	1255	1290	1366	1950	1255	1290	1184	1950	1255	1290	1366	
	160	1950	1255	1290	1366	1950	1255	1290	1184	1950	1255	1290	1366	
	180	1950	1255	1290	1366	1950	1255	1290	1184	1950	1255	1290	1366	
	200	1950	1255	1290	1366	1950	1255	1290	1184	1950	1255	1290	1366	
	225	1950	1255	1290	1366	1950	1255	1290	1184	1950	1255	1290	1366	
	800	132	2130	\	1450	1548	2130	\	1450	1330	2130	\	1450	1548
900	160	2130	\	1450	1548	2130	\	1450	1330	2130	\	1450	1548	
	180	2130	\	1450	1548	2130	\	1450	1330	2130	\	1450	1548	
	200	2130	\	1450	1548	2130	\	1450	1330	2130	\	1450	1548	
	225	2130	\	1450	1548	2130	\	1450	1330	2130	\	1450	1548	
	250	2130	\	1450	1548	2130	\	1450	1330	2130	\	1450	1548	
	900	132	2450	\	1570	1748	2450	\	1570	1508	2450	\	1570	1748
1000	160	2450	\	1570	1748	2450	\	1570	1508	2450	\	1570	1748	
	180	2450	\	1570	1748	2450	\	1570	1508	2450	\	1570	1748	
	200	2450	\	1570	1748	2450	\	1570	1508	2450	\	1570	1748	
	225	2450	\	1570	1748	2450	\	1570	1508	2450	\	1570	1748	
	250	2450	\	1570	1748	2450	\	1570	1508	2450	\	1570	1748	
	280	2450	\	1570	1748	2450	\	1570	1508	2450	\	1570	1748	
	1000	132	2650	\	1700	1910	2650	\	1700	1641	2650	\	1700	1910
	160	2650	\	1700	1910	2650	\	1700	1641	2650	\	1700	1910	
180	2650	\	1700	1910	2650	\	1700	1641	2650	\	1700	1910		
200	2650	\	1700	1910	2650	\	1700	1641	2650	\	1700	1910		
225	2650	\	1700	1910	2650	\	1700	1641	2650	\	1700	1910		
250	2650	\	1700	1910	2650	\	1700	1641	2650	\	1700	1910		
280	2650	\	1700	1910	2650	\	1700	1641	2650	\	1700	1910		

SYH-R(K)

		0°			90°			180°		
左旋 LG Left Hand										
右旋 RD Right Hand										
型号 Model	电机 机座型号 Motor Frame Size	A	B	C	A	B	C	A	B	C
280	71	840	612	568	840	612	516	840	612	568
	80	840	612	568	840	612	516	840	612	568
	90	840	612	568	840	612	516	840	612	568
	100	840	612	568	840	612	516	840	612	568
	112	840	612	568	840	612	516	840	612	568
	132	840	612	568	840	612	516	840	612	568
315	71	880	617	628	880	617	568	880	617	628
	80	880	617	628	880	617	568	880	617	628
	90	880	617	628	880	617	568	880	617	628
	100	880	617	628	880	617	568	880	617	628
	112	880	617	628	880	617	568	880	617	628
	132	880	617	628	880	617	568	880	617	628
355	71	940	655	705	940	655	628	940	655	705
	80	940	655	705	940	655	628	940	655	705
	90	940	655	705	940	655	628	940	655	705
	100	940	655	705	940	655	628	940	655	705
	112	940	655	705	940	655	628	940	655	705
	132	940	655	705	940	655	628	940	655	705
400	80	1130	736	786	1130	736	613	1130	736	786
	90	1130	736	786	1130	736	613	1130	736	786
	100	1130	736	786	1130	736	613	1130	736	786
	112	1130	736	786	1130	736	613	1130	736	786
	132	1130	736	786	1130	736	613	1130	736	786
	160	1130	736	786	1130	736	613	1130	736	786
450	90	1210	827	890	1210	827	789	1210	827	890
	100	1210	827	890	1210	827	789	1210	827	890
	112	1210	827	890	1210	827	789	1210	827	890
	132	1210	827	890	1210	827	789	1210	827	890
	160	1210	827	890	1210	827	789	1210	827	890
	180	1210	827	890	1210	827	789	1210	827	890
500	90	1290	918	981	1290	918	863	1290	918	981
	100	1290	918	981	1290	918	863	1290	918	981
	112	1290	918	981	1290	918	863	1290	918	981
	132	1290	918	981	1290	918	863	1290	918	981
	160	1290	918	981	1290	918	863	1290	918	981
	180	1290	918	981	1290	918	863	1290	918	981

SYH-R(K)

		0°			90°			180°		
左旋 LG Left Hand										
右旋 RD Right Hand										
型号 Model	电机 机座型号 Motor Frame Size	A	B	C	A	B	C	A	B	C
560	90	1410	1030	1093	1410	1030	956	1410	1030	1093
	100	1410	1030	1093	1410	1030	956	1410	1030	1093
	112	1410	1030	1093	1410	1030	956	1410	1030	1093
	132	1410	1030	1093	1410	1030	956	1410	1030	1093
	160	1410	1030	1093	1410	1030	956	1410	1030	1093
	180	1410	1030	1093	1410	1030	956	1410	1030	1093
	200	1410	1030	1093	1410	1030	956	1410	1030	1093
	630	90	1510	1157	1220	1510	1157	1062	1510	1157
100		1510	1157	1220	1510	1157	1062	1510	1157	1220
112		1510	1157	1220	1510	1157	1062	1510	1157	1220
132		1510	1157	1220	1510	1157	1062	1510	1157	1220
160		1510	1157	1220	1510	1157	1062	1510	1157	1220
180		1510	1157	1220	1510	1157	1062	1510	1157	1220
710	100	1730	1303	1366	1730	1303	1491	1730	1303	1366
	112	1730	1303	1366	1730	1303	1491	1730	1303	1366
	132	1730	1303	1366	1730	1303	1491	1730	1303	1366
	160	1730	1303	1366	1730	1303	1491	1730	1303	1366
	180	1730	1303	1366	1730	1303	1491	1730	1303	1366
	200	1730	1303	1366	1730	1303	1491	1730	1303	1366
800	100	1870	1468	1548	1870	1468	1330	1870	1468	1548
	112	1870	1468	1548	1870	1468	1330	1870	1468	1548
	132	1870	1468	1548	1870	1468	1330	1870	1468	1548
	160	1870	1468	1548	1870	1468	1330	1870	1468	1548
	180	1870	1468	1548	1870	1468	1330	1870	1468	1548
	200	1870	1468	1548	1870	1468	1330	1870	1468	1548
900	132	2170	1648	1748	2170	1648	1748	2170	1648	1748
	160	2170	1648	1748	2170	1648	1748	2170	1648	1748
	180	2170	1648	1748	2170	1648	1748	2170	1648	1748
	200	2170	1648	1748	2170	1648	1748	2170	1648	1748
	225	2170	1648	1748	2170	1648	1748	2170	1648	1748
	250	2170	1648	1748	2170	1648	1748	2170	1648	1748
1000	280	2170	1648	1748	2170	1648	1748	2170	1648	1748
	132	2300	1810	1910	2300	1810	1641	2300	1810	1910
	160	2300	1810	1910	2300	1810	1641	2300	1810	1910
	180	2300	1810	1910	2300	1810	1641	2300	1810	1910
	200	2300	1810	1910	2300	1810	1641	2300	1810	1910
	225	2300	1810	1910	2300	1810	1641	2300	1810	1910

SYH系列风机运行极限

SYH Series Fan Operational Limits

			280	315	355	400	450	500	560	630	710	800	900	1000	1120	1250	1400	1600
极限吸收功率 Max.Absorbed power	R	KW	5.5	4.8	5.5	6	8	12	14	20	20	/	/	/	/	/	/	/
	K	KW	8	8	15	15	15	22	30	35	40	30	43	55	/	/	/	/
	Z	KW	/	/	/	/	/	30	38.5	40	60	65	65	80	180	220	280	350
	R2	KW	5.5	6.5	8.5	8.5	12	13	/	/	/	/	/	/	/	/	/	/
	K2	KW	/	/	13	13	18.5	22	32	/	/	/	/	/	/	/	/	/
极限转速 Max.Speed	R	rpm	4000	3200	2800	2400	2200	2000	1800	1700	1400	/	/	/	/	/	/	/
	K	rpm	4500	4000	3800	3200	2800	2500	2300	2000	1700	1300	1200	1100	/	/	/	/
	Z	rpm	/	/	/	/	/	2800	2500	2200	2000	1600	1400	1300	1450	1300	1150	1000
	R2	rpm	3200	2800	2600	2100	1800	1600	/	/	/	/	/	/	/	/	/	/
	K2	rpm	/	/	3000	2400	2200	2000	1800	/	/	/	/	/	/	/	/	/
极限温度 (最低-20℃) Air Temperature Limits(Min-20℃)	R/R2	Max.℃	85	85	85	85	85	85	85	85	85	/	/	/	/	/	/	/
	K/K2	Max.℃	85	85	85	85	85	85	85	85	85	85	85	85	/	/	/	/
	Z	Max.℃	/	/	/	/	/	85	85	85	85	85	85	85	85	85	85	85
风机质量 Fan Weight	R	Kg	22	32.6	42.7	50.6	67.5	84.2	142	168	223	/	/	/	/	/	/	/
	K	Kg	32	42.6	54.7	63.6	82.5	104.2	171	197	271	300	481.5	530	/	/	/	/
	Z	Kg	/	/	/	/	/	107	174	200	274	304	485	535	690	970	1370	1500
	R2	Kg	46	67	91	107	143	176	/	/	/	/	/	/	/	/	/	/
	K2	Kg	/	/	111	127	173	217	358	/	/	/	/	/	/	/	/	/

本样本中所述的风机特性，如尺寸、性能参数等，本公司保留更改的权利，恕不另行通知；如有不明之处，请来电询问。
This fan features described in the sample, such as size, performance parameters, the Company reserves the right to change without notice; if unknown place, please call us.

SYQS 系列离心式空调风机

Centrifugal Ventilators

浙江亿利达风机股份有限公司特此证明，此处所示 SYQS 系列离心风机获得了加盖 AMCA 印章的授权。所示额定值系根据 AMCA 出版物 211 和 AMCA 出版物 311 所进行测试和程序确定，并符合 AMCA 认证额定值计划的要求。

这里描述的所有离心风机都已经取得了 AMCA 印章，其认证数据见第 169 页到 183 页。

Zhejiang Yilida Ventilator Co.,Ltd. certifies that the SYQS Series fans shown herein are licensed to bear the AMCA Seal. The ratings shown are based on tests and procedures performed in accordance with AMCA Publication 211 and AMCA Publication 311 and comply with the requirements of the AMCA Certified Ratings Program.

All the Centrifugal Fans described herein are licensed to bear the AMCA Seal, and their certified ratings are shown on pages 169through 183.

